



NFI Transportation Cab Kits

- MKNFITRA100 - NFI Transportation Blue Sleeper Cab Kit
- MKNFITRA100VNL - NFI Transportation Blue Sleeper Cab with airshield window Kit
- MKNFITRA105 - NFI Transportation White Sleeper Cab Kit
- MKNFITRA105VNL - NFI Transportation White Sleeper Cab with airshield window Kit
- MKNFITRA126 - NFI Transportation Blue Day Cab Kit
- MKNFITRA126A- National Distribution Center Blue Day Cab Kit
- MKNFITRA130 - NFI Transportation White Day Cab Kit
- MKNFITRA130A - National Distribution Center White Day Cab Kit
- MKNFITRA142 - NFI On-Road White Yard Truck Kit
- MKNFITRA143 - NFI Off-Road White Yard Truck Kit
- MKNFITRA150 - NFI On-Road White Yard Truck Kit
- MKNFITRA151 - NFI Off-Road White Yard Truck Kit
- MKNFITRA162 - National Freight Owner Operator Blue Cab Kit
- MKNFITRA163 - National Freight Owner Operator White Cab Kit
- MKNFITRA173 - National Freight Owner Operator Cab Kit
- MKNFITRA100C - NFI IPD, LLC Canada Blue Sleeper Cab Kit
- MKNFITRA105C - NFI IPD, LLC Canada White Sleeper Cab Kit
- MKNFITRA125C - NFI IPD, LLC Canada White Day Cab Kit
- MKNFITRA126C - NFI IPD, LLC Canada Blue Day Cab Kit
- MKNFITRA173C - NFI IPD, LLC Canada Owner Operator Cab Kit
- MKNFITRA164 - Decal Placement Instructions
- NFI MHE Fleet Services Van Small logo layout
- NFI MHE Fleet Services Van Large logo layout
- MKNFITRL169 - Box/Straight Truck Kit

Updated 4-1-2021



Kit Number MKNFITRA100

NFI Transportation
Blue Sleeper Cab Kit
Updated 4-1-2021

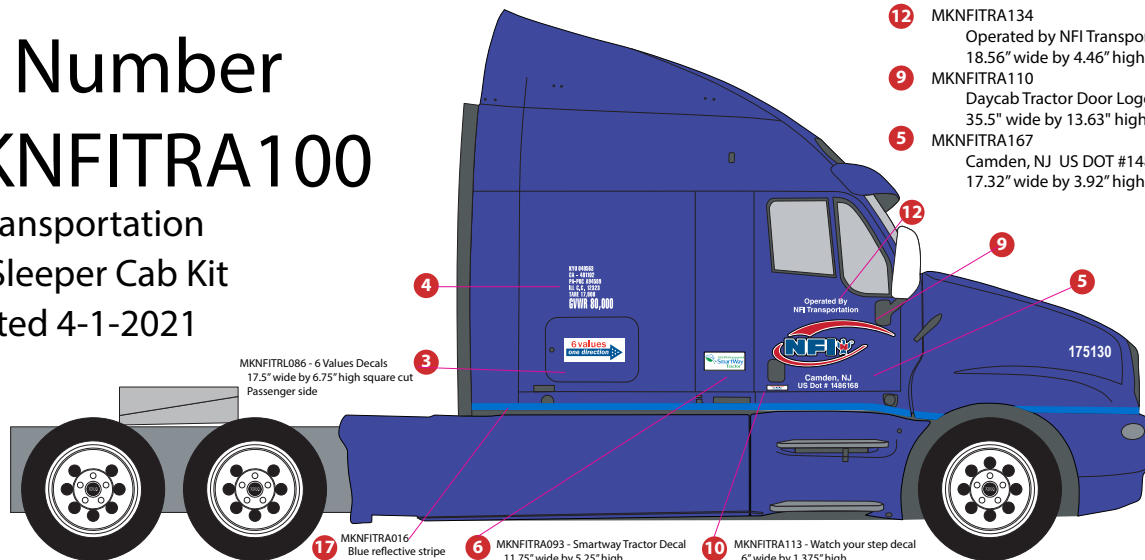

- 12 MKNFITRA134
Operated by NFI Transportation
18.56" wide by 4.46" high white
- 9 MKNFITRA110
Daycab Tractor Door Logo
35.5" wide by 13.63" high
- 5 MKNFITRA167
Camden, NJ US DOT #1486168
17.32" wide by 3.92" high white

- 13 MKNFITRA148 - NFI Cares Decal
7" wide by 2" high
Place on the dashboard
- 12 MKNFITRA134
Operated by NFI Transportation
18.56" wide by 4.46" high white
- 9 MKNFITRA110
Daycab Tractor Door Logo
35.5" wide by 13.63" high
- 5 MKNFITRA167
Camden, NJ US DOT #1486168
17.32" wide by 3.92" high white



- 16 MKNFITRA016
Blue reflective stripe
- 15 MKNFITRA174 - Driver Reminder
3" wide by 3" high
Place on the back of the visor inside cab
- 14 MKNFITRA164 - Tire Check Reminder
2.75" wide by 1.75" high
Placement instruction sheet attached
- 13 MKNFITRA148 - NFI Cares Decal
7" wide by 2" high
Place on the dashboard
- 12 MKNFITRA134
Operated by NFI Transportation
18.56" wide by 4.46" high white
- 9 MKNFITRA110
Daycab Tractor Door Logo
35.5" wide by 13.63" high
- 5 MKNFITRA167
Camden, NJ US DOT #1486168
17.32" wide by 3.92" high white
- 4 MKNFITRA089 - Fuel Permit
with no dot #
Shown at 50% of original
12.75" w by 12.75" h
Background color of blue does not print, is there to show the white profile cut letters.
- 3 MKNFITRA093 - Smartway Tractor Decal
11.75" wide by 5.25" high square cut
Passenger side
- 2 MKNFITRA026 - DOT Inspection Decal
3.5" wide by 5" high
Place on drivers wing window facing outside

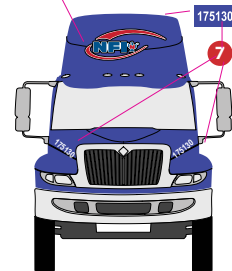

PART NUMBER	QTY	DESCRIPTION
1 MKNFITRA025	1	BREAKDOWN SUPPORT
2 MKNFITRA026	1	DOT Inspection Decal
3 MKNFITRL086	1	6 VALUES DECAL PASSENGER
4 MKNFITRA089	2	FUEL PERMIT
5 MKNFITRA167	2	LOCATION/DOT #
6 MKNFITRA093	2	SMARTWAY TRACTOR DECAL
7 MKNFITRA094	3	5" WHITE 6 DIGIT UNIT #'S
8 MKNFITRL099	1	6 VALUES DECAL DRIVERS
9 MKNFITRA110	2	DOOR LOGO
10 MKNFITRA113	2	WATCH YOUR STEP 3-POINTS
11 MKNFITRA114	1	AIR SHIELD LOGO
12 MKNFITRA134	2	OPERATED BY NFI TRANS...
13 MKNFITRA148	1	NFI CARES DECAL
14 MKNFITRA164	1	TIRE CHECK REMINDER
15 MKNFITRA174	1	DRIVER REMINDER (FOR VISOR)
16 MKNFITRA016	1	BLUE REFLECTIVE 2" X 25' ROLL
17 MKNFITRA180	1	ELECTRONIC LOG 8" X 2.5"



Kit Number

MKNFITRA100

NFI Transportation

Blue Sleeper Cab Kit Parts

Updated 4-1-2021

- 1** MKNFITRA025 - Breakdown Support Decal
3.75" wide by 2.75" high
Place in dash



- 2** MKNFITRA026 - DOT Inspection Decal
3.5" wide by 5" high
Place on drivers wing window facing outside

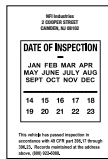

- 3** MKNFITRL086 - 6 Values Decals Passenger
17.5" wide by 6.75" high
Square cut material



- 4** MKNFITRA089 - Fuel Permit
12.75" by 12.75"
White diecut



- 5** MKNFITRA167 - Location and Dot Profile
17.93" wide by 3.92" high
White diecut
note, blue background not supplied, this is to show the white diecut



- 6** MKNFITRA093 - Smartway Tractor Decal
11.75" wide by 5.25" high
Blue and Green on white square cut



- 7** MKNFITRL094 - UNIT NUMBER
5" White 6 digit Unit #'s
Diecut material



- 8** MKNFITRL099 - 6 Values Decals Drivers
17.5" wide by 6.75" high blue and red on white square cut Passenger side



- 9** MKNFITRA110 - Tractor Door Logo
35.5" wide by 13.63" high
Red and Blue on reflective diecut



- 10** MKNFITRA113
Watch Your Step
3 points of contact decal
Red and blue on white
6" wide by 1.375" high

WATCH YOUR STEP
USE 3-POINTS
OF CONTACT

- 11** MKNFITRA114 - Air Shield Logo
47" wide by 18" high
Red and Blue
on reflective diecut



- 12** MKNFITRA134 -
Operated By NFI Transportation
18.56" by 4.46" White diecut

Operated By
NFI Transportation

- 13** MKNFITRA148 - NFI Cares
7" wide by 2" high
Red and blue on white
Place on the dashboard



- 14** MKNFITRA164 - Tire Check Reminder
2.75" wide by 1.75" high
Green on white square cut
See placement instruction sheet



- 15** MKNFITRA174 - Driver Reminder
3" wide by 3" high
Black on white square cut
Place on the back of the visor inside cab



- 16** MKNFITRA016 - Blue reflective 2" X 25' Roll

- 17** MKNFITRA180 - Electronic Log Decal
8" wide by 2.5" high square cut

DRIVER USING
ELECTRONIC LOGS

Kit Number MKNFITRA100VNL

NFI Transportation
Blue Sleeper Cab Kit
with airshield window
Updated 4-1-2021

- 11 MKNFITRA134
Operated by NFI Transportation
18.56" wide by 4.46" high white
- 9 MKNFITRA110
Daycab Tractor Door Logo
35.5" wide by 13.63" high
- 5 MKNFITRA167
Camden, NJ US DOT #1486168
17.32" wide by 3.92" high white

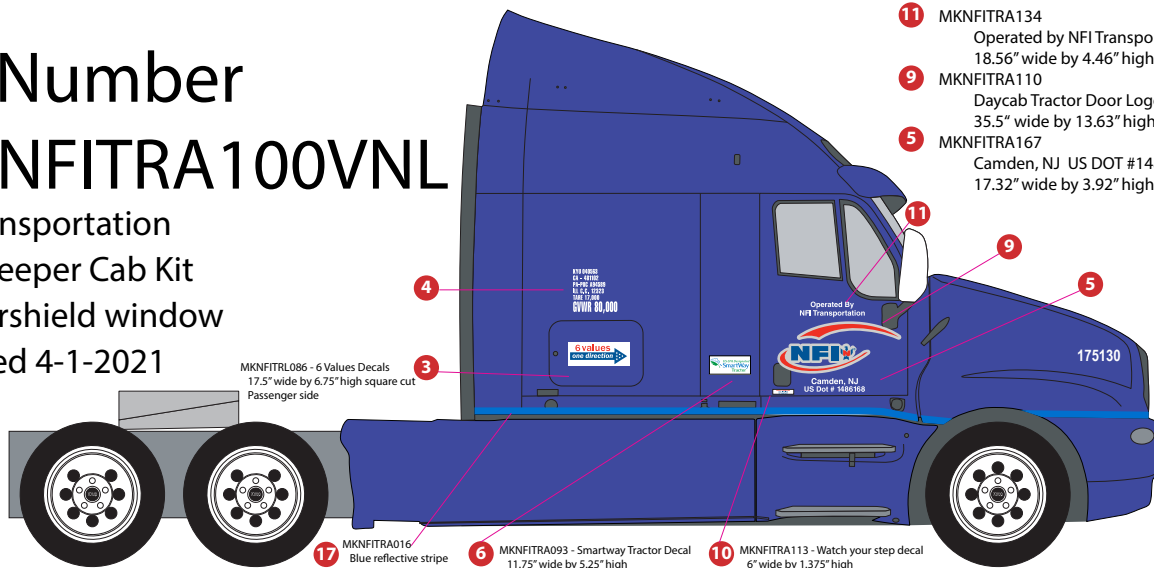

- 12 MKNFITRA148 - NFI Cares Decal
7" wide by 2" high
Place on the dashboard
- 11 MKNFITRA134
Operated by NFI Transportation
18.56" wide by 4.46" high white
- 9 MKNFITRA110
Daycab Tractor Door Logo
35.5" wide by 13.63" high
- 5 MKNFITRA167
Camden, NJ US DOT #1486168
17.32" wide by 3.92" high white



- 4 Fuel Permit as profile with no dot#
Sh own at 50% of original
12.75" w by 12.75" h
Ba ckg round color of blue does not print , is there to sh ow the white profile cut lette rs.
- 14 MKNFITRA174 -
Driver Reminder
3" wide by 3" high
Place on the back of the visor inside cab



Attention: rtf Driver
Your tractor is equipped with an automatic Braking and Lane Departure System.
Please contact your Driver Manager as soon as possible to review the System Owner training session. MyLearning and/or MyRFI
mknfitra@nfiindustries.com
www.nfi.com

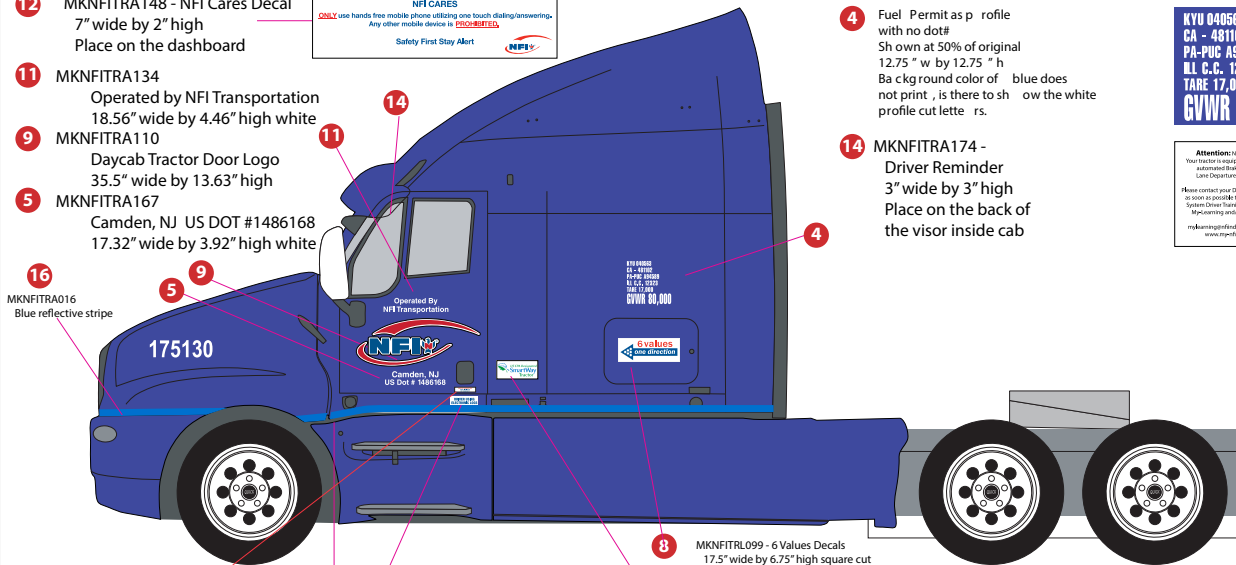

- 16 MKNFITRA016
Blue reflective stripe
- 10 MKNFITRA113 - Watch your step Decal
6" wide by 1.375" high
- 9 MKNFITRA110
Daycab Tractor Door /Airshield Logo
35.5" wide by 13.63" high

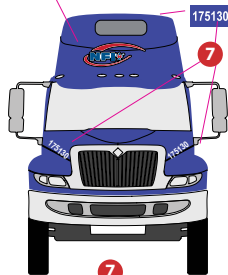

MKNFITRA094
5" 6 DIGIT UNIT #S WHITE
Note: place on back of cab below window

- 13 MKNFITRA164 - Tire Check Reminder
2.75" wide by 1.75" high
Placement instruction sheet attached
- 15 MKNFITRA180 - Electronic Logs
8" wide by 2.5" high
- 8 MKNFITRL099 - 6 Values Decals
17.5" wide by 6.75" high square cut
Drivers side
- 6 MKNFITRA093 - Smartway Tractor Decal
11.75" wide by 5.25" high square cut
- 2 MKNFITRA026 - DOT Inspection Decal
3.5" wide by 5" high
Place on drivers wing window facing outside



PART NUMBER QTY DESCRIPTION

PART NUMBER	QTY	DESCRIPTION
1	1	MKNFITRA025 BREAKDOWN SUPPORT
2	1	MKNFITRA026 DOT Inspection Decal
3	1	MKNFITRL086 6 VALUES DECAL PASSENGER
4	2	MKNFITRA089 FUEL PERMIT
5	2	MKNFITRA167 LOCATION/DOT #
6	2	MKNFITRA093 SMARTWAY TRACTOR DECAL
7	3	MKNFITRA094 5" WHITE 6 DIGIT UNIT #S
8	1	MKNFITRL099 6 VALUES DECAL DRIVERS
9	3	MKNFITRA110 CAB DOOR/AIRSHEILD LOGO
10	2	MKNFITRA113 WATCH YOUR STEP 3-POINTS
11	2	MKNFITRA134 OPERATED BY NFI TRANS...
12	1	MKNFITRA148 NFI CARES DECAL
13	1	MKNFITRA164 TIRE CHECK REMINDER
14	1	MKNFITRA174 DRIVER REMINDER (FOR VISOR)
15	1	MKNFITRA180 ELECTRONIC LOG
16	1	MKNFITRA016 BLUE REFLECTIVE 2" X 25' ROLL



Kit Number

MKNFITRA100VNL

NFI Transportation

Blue Sleeper Cab Kit Parts

Updated 4-1-2021

- 1** MKNFITRA025 - Breakdown Support Decal
3.75" wide by 2.75" high
Place in dash



- 2** MKNFITRA026 - DOT Inspection Decal
3.5" wide by 5" high
Place on drivers wing
window facing outside

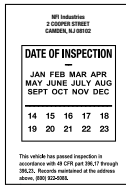

- 3** MKNFITRL086 - 6 Values Decals Passenger
17.5" wide by 6.75" high
Squarecut material



- 4** MKNFITRA089 - Fuel Permit
12.75" by 12.75"
White diecut



- 5** MKNFITRA167 - Location and Dot Profile
17.93" wide by 3.92" high
White diecut
note, blue background not supplied, this is to show the white profile



- 6** MKNFITRA093 - Smartway Tractor Decal
11.75" wide by 5.25" high



- 7** MKNFITRL094 - UNIT NUMBER
5" White 6 digit Unit #'s
Diecut material



- 8** MKNFITRL099 - 6 Values Decals Drivers
17.5" wide by 6.75" high square cut
Passenger side



- 9** MKNFITRA110 - Tractor Logo
35.5" wide by 13.63" high
Red and Blue on reflective diecut



- 10** MKNFITRA113
Watch Your Step
3 points of contact decal
6" wide by 1.375" high



- 11** MKNFITRA134 -
Operated By NFI Transportation
18.56" by 4.46" White diecut



- 12** MKNFITRA148 - NFI Cares
7" wide by 2" high
Place on the dashboard



- 13** MKNFITRA164 - Tire Check Reminder
2.75" wide by 1.75" high
See placement instruction sheet



- 14** MKNFITRA174 - Driver Reminder
3" wide by 3" high
Place on the back of the visor
inside cab



- 15** MKNFITRA180 - Electronic Log Decal
8" wide by 2.5" high square cut



- 16** MKNFITRA016 - Blue reflective stripe
2" high by 25' roll

Kit Number MKNFITRA105 NFI Transportation White Sleeper Cab Kit Updated 4-1-2021

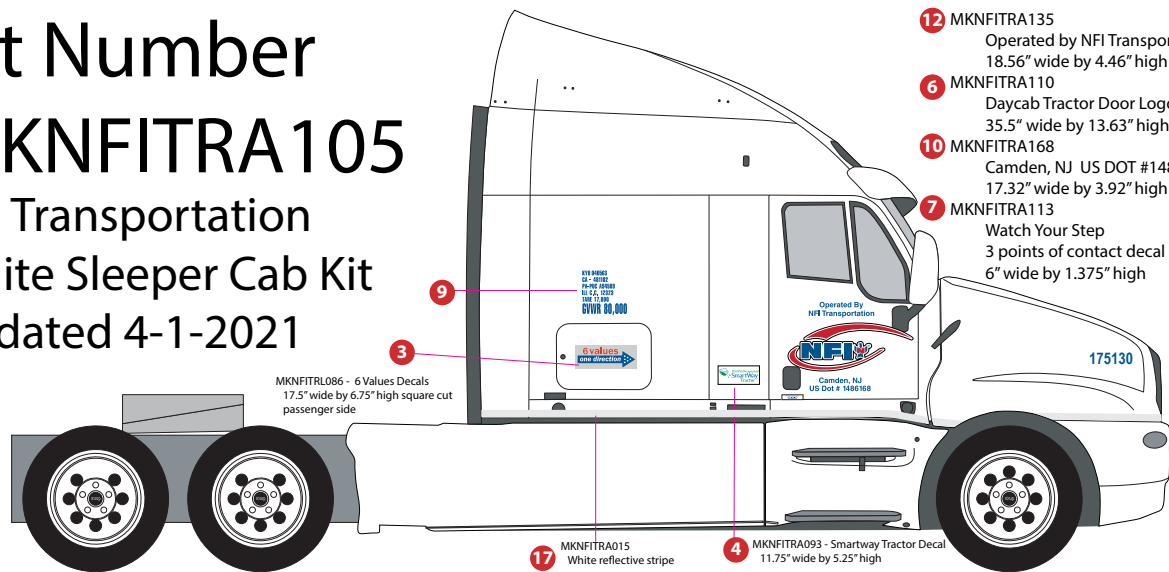

MKNFITRL086 - 6 Values Decals
17.5" wide by 6.75" high square cut
passenger side

- 12 MKNFITRA135
Operated by NFI Transportation
18.56" wide by 4.46" high
- 6 MKNFITRA110
Daycab Tractor Door Logo
35.5" wide by 13.63" high
- 10 MKNFITRA168
Camden, NJ US DOT #1486168
17.32" wide by 3.92" high
- 7 MKNFITRA113
Watch Your Step
3 points of contact decal
6" wide by 1.375" high

- 13 MKNFITRA148 - NFI Cares Decal
7" wide by 2" high
Place on the dashboard
- 12 MKNFITRA135
Operated by NFI Transportation
18.56" wide by 4.46" high
- 6 MKNFITRA110
Daycab Tractor Door Logo
35.5" wide by 13.63" high
- 10 MKNFITRA123
Camden, NJ US DOT #1486168
17.32" wide by 3.92" high



9 Fuel Permit as profile
with no dot#
Shown at 50% of original
12.75 wby 12.75 h

KYU 040563
CA - 481102
PA-PUC A94589
ILL C.G. 12923
TARE 17,000
GVWR 80,000

- 15 MKNFITRA174 -
Driver Reminder
3" wide by 3" high
Place on the back of
the visor inside cab

Attention: NFI Driver
Your vehicle is equipped with an
Automated Braking and
Lane-Departure System.
Please contact your Driver Manager
as soon as possible to review the
System Driver Training video on
MyLearning and/or NFI-NFI
mknfi@governmentsolutions.com
www.nfi.com

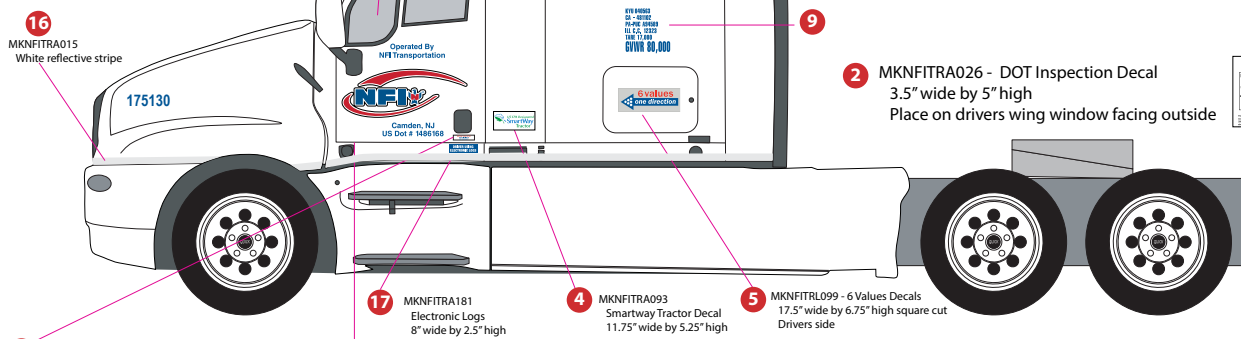

MKNFITRA015
White reflective stripe

- 2 MKNFITRA026 - DOT Inspection Decal
3.5" wide by 5" high
Place on drivers wing window facing outside



- 7 MKNFITRA113
Watch your step Decal
6" wide by 1.375" high
- 8 MKNFITRA114
NEW Air Shield logo
47" wide by 18" high
- 11 MKNFITRA131
5" 6 DIGIT UNIT #'S BLUE
Note: place on back of cab below
window
- 14 MKNFITRA164 - Tire Check Reminder
2.75" wide by 1.75" high
Placement instruction sheet attached

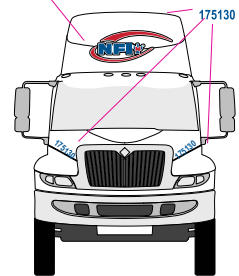

- 1 MKNFITRA025 -
Breakdown Support Decal
3.75" wide by 2.75" high
Placement in dash



PART NUMBER	QTY	DESCRIPTION
1	1	MKNFITRA025 BREAKDOWN SUPPORT
2	1	MKNFITRA026 DOT INSPECTION Decal
3	1	MKNFITRL086 6 VALUES DECAL PASSENGER
4	2	MKNFITRA093 SMARTWAY TRACTOR
5	1	MKNFITRL099 6 VALUES DECAL DRIVERS
6	2	MKNFITRA110 CAB DOOR LOGO
7	2	MKNFITRA113 WATCH YOUR STEP 3-POINTS
8	1	MKNFITRA114 AIR SHIELD LOGO
9	2	MKNFITRA127 FUEL PERMIT BLUE
10	2	MKNFITRA168 LOCATION/DOT # BLUE
11	3	MKNFITRA131 5" BLUE 6 DIGIT UNIT #'S
12	2	MKNFITRA135 OPERATED BY NFI TRANS...
13	1	MKNFITRA148 NFI CARES DECAL
14	1	MKNFITRA164 TIRE CHECK REMINDER
15	1	MKNFITRA174 DRIVER REMINDER (FOR VISOR)
16	1	MKNFITRA015 WHITE REFLECTIVE 2" X 25' ROLL
17	1	MKNFITRA181 ELECTRONIC LOG



Kit Number

MKNFITRA105

NFI Transportation

White Sleeper Cab Kit Parts

Updated 4-1-2021

- 1** MKNFITRA025 - Breakdown Support Decal
3.75" wide by 2.75" high
Blue on white square cut
Place in dash



- 2** MKNFITRA026 - DOT Inspection Decal
3.5" wide by 5" high
Place on drivers wing window facing outside

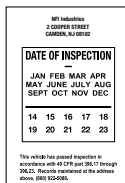

- 3** MKNFITRL086 - 6 Values Decals
17.5" wide by 6.75" high square cut
Blue and red on white
Passenger side



- 4** MKNFITRA093 - Smartway Tractor Decal
11.75" wide by 5.25" high
Green and blue on white square cut



- 5** MKNFITRL099 - 6 Values Decals
17.5" wide by 6.75" high square cut
Red and blue on white
Driver side



- 6** MKNFITRA110 - Tractor Door Logo
35.5" wide by 13.63" high
Red and Blue on reflective diecut



- 7** MKNFITRA113
Watch Your Step
3 points of contact decal
6" wide by 1.375" high
Red and blue on white square cut



- 8** MKNFITRA114 - Air Shield Logo
47" wide by 18" high
Red and Blue, Diecut on reflective material



- 9** MKNFITRA127 - Fuel Permit
12.75" by 12.75"
Blue diecut

KYU 040563
CA - 24713
PA-PUC A94589
ILL. C.C. 12323
TARE 17,000
GVWR 80,000

- 10** MKNFITRA168 - Location and DOT profile
17.32" wide by 3.92" high
Blue diecut

Camden, NJ
US Dot # 1486168

- 11** MKNFITRL131 - UNIT NUMBER
5" Blue 6 digit Unit #'s
Blue diecut

0123456789

- 12** MKNFITRA135 - Operated By NFI Transportation
18.56" by 4.46" Blue diecut

Operated By
NFI Transportation

- 13** MKNFITRA148 - NFI Cares
7" wide by 2" high
Blue and red on white
Square cut Place on the dashboard



- 14** MKNFITRA164 - Tire Check Reminder
2.75" wide by 1.75" high
Green on white square cut
See placement instruction sheet



- 15** MKNFITRA174 - Driver Reminder
3" wide by 3" high
Place on back of visor inside cab
Black on white square cut



- 16** MKNFITRA015 - White reflective 2" X 25' Roll

- 17** MKNFITRA181 - Electronic log decal
8" wide by 2.5" high
Blue on white square cut



Kit Number

MKNFITRA105VNL

NFI Transportation
White Sleeper Cab with
airshield window Kit
Updated 4-1-2021

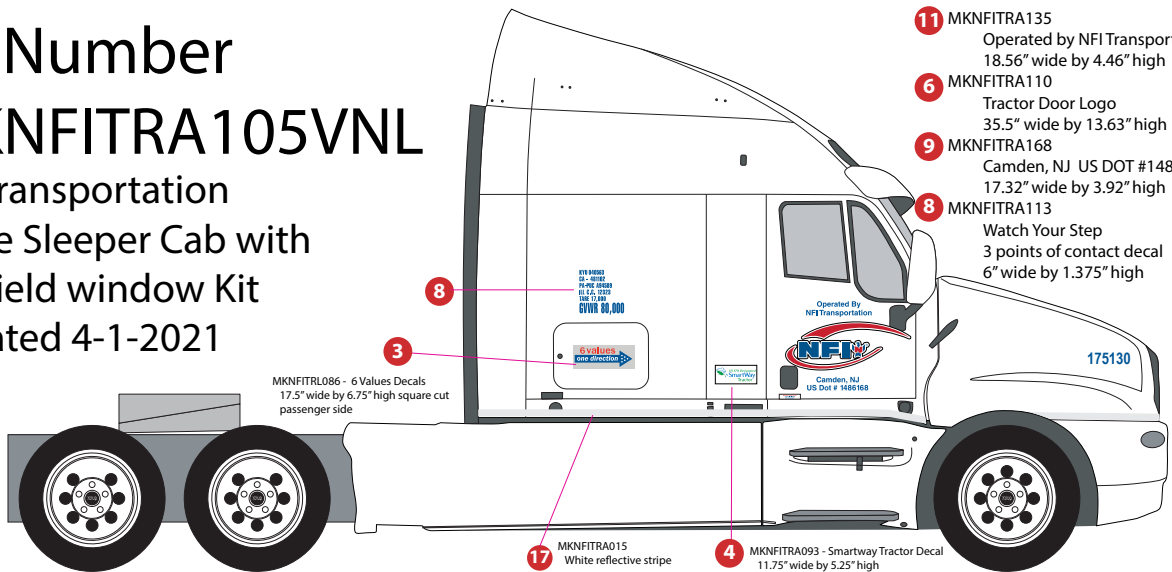

- 11 MKNFITRA135
Operated by NFI Transportation
18.56" wide by 4.46" high
- 6 MKNFITRA110
Tractor Door Logo
35.5" wide by 13.63" high
- 9 MKNFITRA168
Camden, NJ US DOT #1486168
17.32" wide by 3.92" high
- 8 MKNFITRA113
Watch Your Step
3 points of contact decal
6" wide by 1.375" high

MKNFITRL086 - 6 Values Decals
17.5" wide by 6.75" high square cut
passenger side

- 12 MKNFITRA148 - NFI Cares Decal
7" wide by 2" high
Place on the dashboard
- 11 MKNFITRA135
Operated by NFI Transportation
18.56" wide by 4.46" high
- 6 MKNFITRA110
Tractor Door Logo
35.5" wide by 13.63" high
- 9 MKNFITRA123
Camden, NJ US DOT #1486168
17.32" wide by 3.92" high
- 7 MKNFITRA113
Watch Your Step
3 points of contact decal
6" wide by 1.375" high



- 17 MKNFITRA015
White reflective stripe
- 4 MKNFITRA093 - Smartway Tractor Decal
11.75" wide by 5.25" high
- 8 MKNFITRA127 - Fuel Permit
Profile with DOT#
12.75" wide by 12.75" high

- 14 MKNFITRA174 -
Driver Reminder
3" wide by 3" high
Place on the back of
the visor inside cab

KYU 040563
CA - 481102
PA-PUC A94589
ILL. C.C. 12323
TARE 17,000
GVWR 80,000

Attention: NFI Driver
Your tractor is equipped with an
automated Braking and
Lane Departure System.
Please contact your Driver Manager
as soon as possible to receive the
System Driver Training video on
MyLearning and/or MyeB!

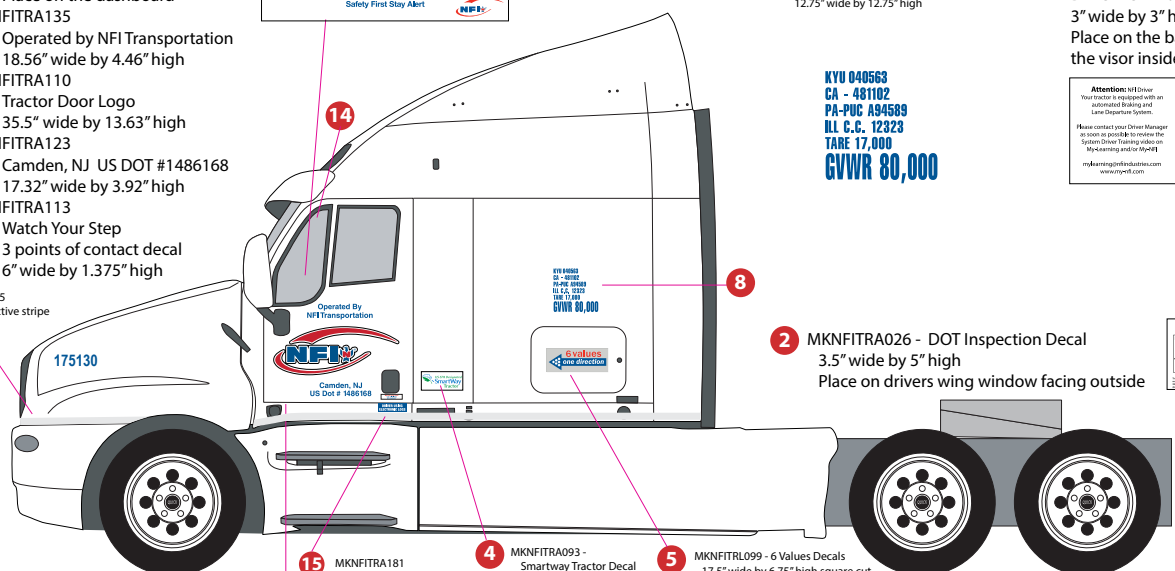

- 16 MKNFITRA015
White reflective stripe
- 10 MKNFITRA131
5" 6 DIGIT UNIT #S BLUE
Note: place on back
of cab below window

MKNFITRA181
Electronic Logs
8" wide by 2.5" high

DRIVER USING ELECTRONIC LOGS

- 15 MKNFITRA093 -
Smartway Tractor Decal
11.75" wide by 5.25" high
- 5 MKNFITRL099 - 6 Values Decals
17.5" wide by 6.75" high square cut
Drivers side
- 13 MKNFITRA164 - Tire Check Reminder
2.75" wide by 1.75" high
Placement instruction sheet attached



- 1 MKNFITRA025 -
Breakdown Support Decal
3.75" wide by 2.75" high
Placement in dash

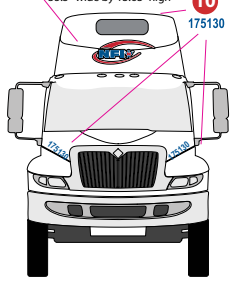

PART NUMBER QTY DESCRIPTION

PART NUMBER	QTY	DESCRIPTION
1	1	MKNFITRA025 BREAKDOWN SUPPORT
2	1	MKNFITRA026 DOT INSPECTION Decal
3	1	MKNFITRL086 6 VALUES DECAL PASSENGER
4	2	MKNFITRA093 SMARTWAY TRACTOR
5	1	MKNFITRL099 6 VALUES DECAL DRIVERS
6	3	MKNFITRA110 CAB DOOR/AIRSHIELD LOGO
7	2	MKNFITRA113 WATCH YOUR STEP 3-POINTS
8	2	MKNFITRA127 FUEL PERMIT BLUE
9	2	MKNFITRA168 LOCATION/DOT # BLUE
10	3	MKNFITRA131 5" BLUE 6 DIGIT UNIT #S
11	2	MKNFITRA135 OPERATED BY NFI TRANS...
12	1	MKNFITRA148 NFI CARES DECAL
13	1	MKNFITRA164 TIRE CHECK REMINDER
14	1	MKNFITRA174 DRIVER REMINDER (FOR VISOR)
15	1	MKNFITRA181 ELECTRONIC LOG DECAL
16	1	MKNFITRA015 WHITE REFLECTIVE 2" X 25' ROLL



Kit Number MKNFITRA105VNL

NFI Transportation
White Sleeper Cab Kit
with airshield window Parts
Updated 4-1-2021

- 1** MKNFITRA025 - Breakdown Support Decal
3.75" wide by 2.75" high
Blue on white square cut
Place in dash



- 2** MKNFITRA026 - DOT Inspection Decal
3.5" wide by 5" high
Place on drivers wing window facing outside

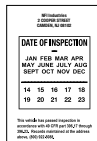

- 3** MKNFITRL086 - 6 Values Decals
17.5" wide by 6.75" high square cut
Red and Blue on white
Passenger side



- 4** MKNFITRA093 - Smartway Tractor Decal
11.75" wide by 5.25" high
Green and blue on white
Square cut



- 5** MKNFITRL099 - 6 Values Decals
17.5" wide by 6.75" high square cut
Red and blue on white
Driver side



- 6** MKNFITRA110 - Drivers Side Tractor Logo
35.5" wide by 13.63" high
Red and Blue on reflective diecut



- 7** MKNFITRA113
Watch Your Step
3 points of contact decal
6" wide by 1.375" high
Red and blue on white square cut



- 8** MKNFITRA127 - Fuel Permit
12.75" by 12.75"
Blue diecut

KYU 040563
CA - 24713
PA-PUC A94589
ILL C.C. 12323
TARE 17,000
GVWR 80,000

- 9** MKNFITRA168 - Location and DOT profile
17.32" wide by 3.92" high
Blue diecut material

Camden, NJ
US Dot # 1486168

- 10** MKNFITRL131 - UNIT NUMBER
5" Blue 6 digit Unit #'s
Diecut material

0123456789

- 11** MKNFITRA135 - Operated By NFI Transportation
18.56" by 4.46" Blue diecut

Operated By
NFI Transportation

- 12** MKNFITRA148 - NFI Cares
7" wide by 2" high
Place on the dashboard
Red and blue on white square cut



- 13** MKNFITRA164 - Tire Check Reminder
2.75" wide by 1.75" high
Green on white square cut
See placement instruction sheet



- 14** MKNFITRA174 - Driver Reminder
3" wide by 3" high
Place on back of visor inside cab
Black on white square cut



- 15** MKNFITRA181 - Electronic log decal
8" wide by 2.5" high
Blue on white square cut

DRIVER USING
ELECTRONIC LOGS

- 16** MKNFITRA015 - White Reflective
2" by 25' Roll

Kit Number MKNFITRA126 NFI Transportation Blue Day Cab Kit Updated 4-1-2021

- MKNFITRA134
Operated by NFI Transportation
18.56" wide by 4.46" high
- MKNFITRA110
Day Cab Tractor Door Logo
35.5" wide by 13.63" high
- MKNFITRA167
Camden, NJ US DOT #1486168
17.32" wide by 3.92" high white
- MKNFITRA113
Watch Your Step
3 points of contact decal
6" wide by 1.375" high

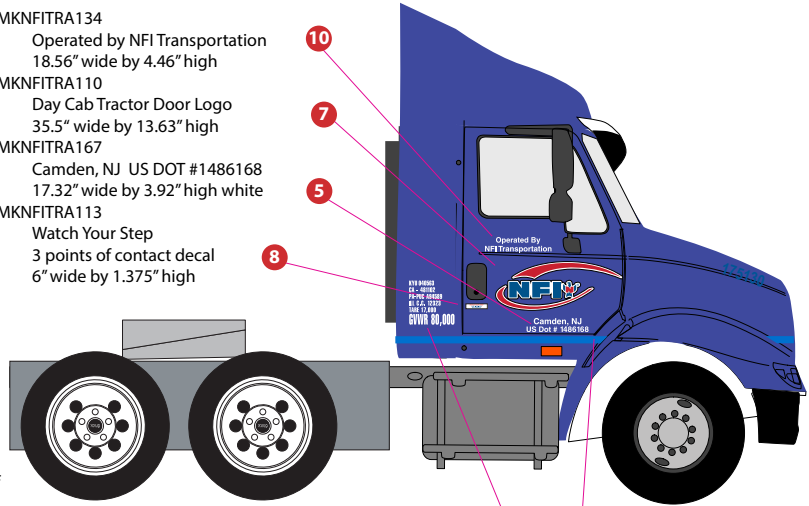

- 2 MKNFITRA025 - Breakdown Support Decal
3.75" wide by 2.75" high
Placement in dash shown at 50%



- 11 MKNFITRA148 - NFI Cares Decal
7" wide by 2" high
Place on the dashboard



- 13 MKNFITRA174 - Driver Reminder
3" wide by 3" high
Place on the back of the visor inside cab



- 3 MKNFITRA026
DOT Inspection Decal
Placed on drivers wing window facing outside
3.5" wide by 5" high

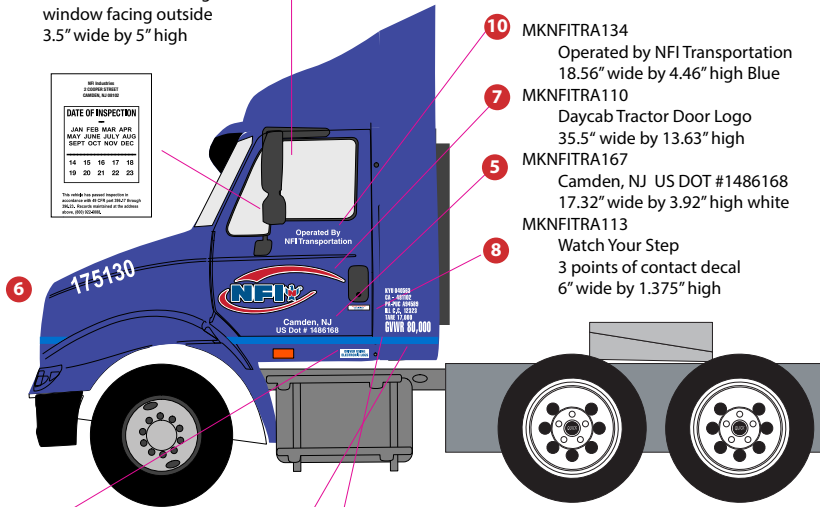
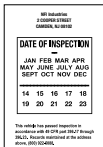

- 10 MKNFITRA134
Operated by NFI Transportation
18.56" wide by 4.46" high Blue
- 7 MKNFITRA110
Daycab Tractor Door Logo
35.5" wide by 13.63" high
- 5 MKNFITRA167
Camden, NJ US DOT #1486168
17.32" wide by 3.92" high white
- 8 MKNFITRA113
Watch Your Step
3 points of contact decal
6" wide by 1.375" high



- 1 MKNFITRA016
Blue reflective stripe

- 5 MKNFITRA089 National Freight Fuel Permit
12.75" wide by 12.75" high

- 9 MKNFITRA114
Air Shield logo
47" wide by 18" high

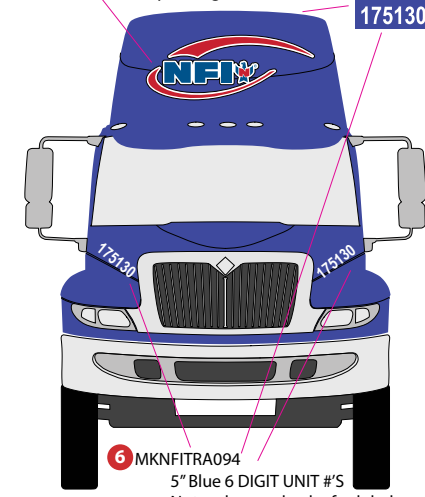

- 175130

- 6 MKNFITRA094
5" Blue 6 DIGIT UNIT #'S
Note: place on back of cab below window

- 14 MKNFITRA180 - Electronic Logs
8" wide by 2.5" high square cut

- 4 MKNFITRA089 National Freight Fuel Permit
12.75" wide by 12.75" high

- 12 MKNFITRA164 - Tire Check Reminder
2.75" wide by 1.75" high
Placement instruction sheet attached



PART NUMBER QTY DESCRIPTION 20% scale

PART NUMBER	QTY	DESCRIPTION	20% scale
1 MKNFITRA016	1	BLUE REFLECTIVE 2" X 25' ROLL	
2 MKNFITRA025	1	BREAKDOWN SUPPORT DECAL	
3 MKNFITRA026	1	DOT INSPECTION DECAL	
4 MKNFITRA089	2	FUEL PERMIT	
5 MKNFITRA167	2	LOCATION/DOT #	
6 MKNFITRA094	3	5" WHITE 6 DIGIT UNIT #'S	
7 MKNFITRA110	2	DAY CAB DOOR LOGO	
8 MKNFITRA113	2	WATCH YOUR STEP 3-POINTS	
9 MKNFITRA114	1	AIR SHIELD LOGO	
10 MKNFITRA134	2	OPERATED BY NFI TRANS...	
11 MKNFITRA148	1	NFI CARES DECAL	
12 MKNFITRA164	1	TIRE CHECK REMINDER	
13 MKNFITRA174	1	DRIVER REMINDER (FOR VISOR)	
14 MKNFITRA180	1	ELECTRONIC LOGO DECAL	



Kit Number MKNFITRA126

NFI Transportation

Blue Day Cab Parts

Updated 4-1-2021

- 1** MKNFITRA016 - 75 Blue Reflective
2" x 25' (2" x 150' per roll)
Place along bottom edge and
through front fender

- 2** MKNFITRA025 - Breakdown Support Decal
3.75" wide by 2.75" high
Blue on white square cut
Placement in dash



- 3** MKNFITRA026 - DOT Expiration Decal
3.5" wide by 5" high
Place on drivers wing window facing outside

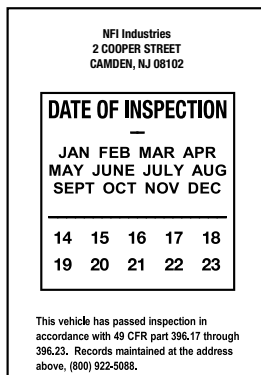

- 4** MKNFITRA089 - National Freight Fuel Permit
12.75" wide by 12.75" high
White diecut (blue does not print)



- 5** MKNFITRA167 - Location and DOT
17.32 wide by 3.92" high
White diecut material (blue does not print)



- 6** MKNFITRL094 - UNIT NUMBER
5" white 6 digit Unit #'s
White diecut



- 7** MKNFITRA110 - Driver Door Decal
35.5" wide by 13.63" high
Red and Blue on reflective diecut



Kit Number MKNFITRA126

NFI Transportation

Blue Day Cab Parts

Updated 4-1-2021

- 8 MKNFITRA113 - Watch your step 3-points of contact
6" wide by 1.375" high
Red and blue on white square cut

**WATCH YOUR STEP
USE 3-POINTS
OF CONTACT**

- 9 MKNFITRA114 - Airshield logo
47" wide by 18" high
Red and Blue on reflective diecut



- 10 MKNFITRL134- Operated by National Freight
18.56" wide by 4.46" high
White diecut

**Operated By
NFI Transportation**

- 11 MKNFITRA148 - NFI Cares
7" wide by 2" high
Red and blue on white square cut
Place on the dashboard

NFI CARES
ONLY use hands free mobile phone utilizing one touch dialing/answering.
Any other mobile device is **PROHIBITED.**

Safety First Stay Alert

- 12 MKNFITRA164 - Tire Check Reminder
2.75" wide by 1.75" high
Green on white square cut
Placement instruction sheet attached

Tire Check Reminder
NFI Standard
Steer Tires = 110 psi
Drive Tires = 100 psi
Trailer Tires = 100 psi
Check Air Pressure Daily
Calibrate Gauge Monthly

- 13 MKNFITRA174 - Driver Reminder
3" wide by 3" high
Black on white square cut
Place on the back of the visor
inside cab

Attention: NFI Driver
Your tractor is equipped with an
automated Braking and
Lane Departure System.

Please contact your Driver Manager
as soon as possible to review the
System Driver Training video on
My-Learning and/or My-NFI

mylearning@nfindustries.com
www.my-nfi.com

- 14 MKNFITRA180 - Electronic Log
8" wide by 2.5" high
Blue on White square cut

**DRIVER USING
ELECTRONIC LOGS**

Kit Number MKNFITRA126A National Distribution Center Blue Day Cab Kit Updated 4-1-2021

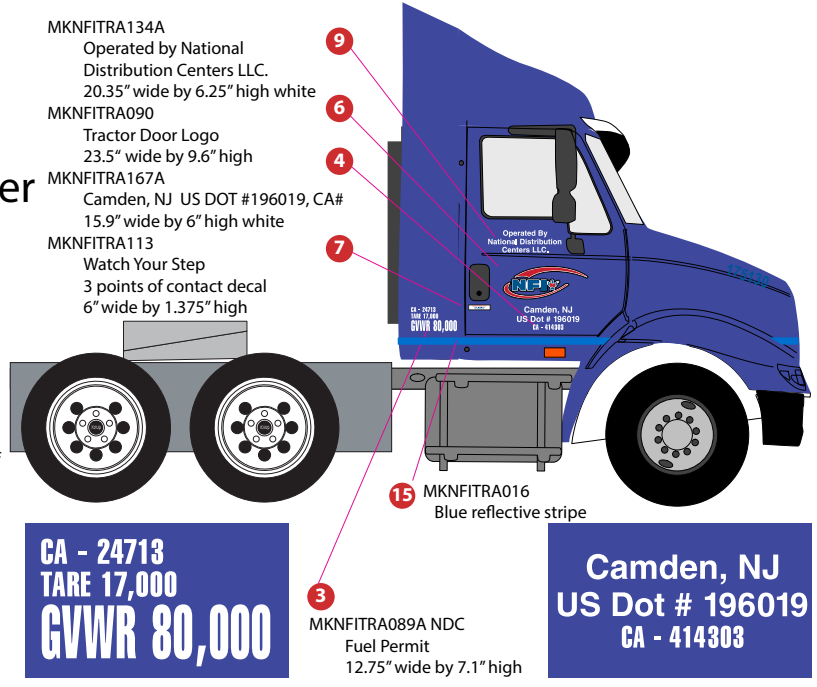

- MKNFITRA134A
Operated by National
Distribution Centers LLC.
20.35" wide by 6.25" high white
- MKNFITRA090
Tractor Door Logo
23.5" wide by 9.6" high
- MKNFITRA167A
Camden, NJ US DOT #196019, CA#
15.9" wide by 6" high white
- MKNFITRA113
Watch Your Step
3 points of contact decal
6" wide by 1.375" high

1 MKNFITRA025 - Breakdown Support Decal
3.75" wide by 2.75" high
Placement in dash
shown at 50%



12 MKNFITRA174 -
Driver Reminder
3" wide by 3" high
Place on the back of
the visor inside cab



10 MKNFITRA148 - NFI Cares Decal
7" wide by 2" high
Place on the dashboard



MKNFITRA026
DOT Inspection Decal
Placed on drivers wing
window facing outside
3.5" wide by 5" high

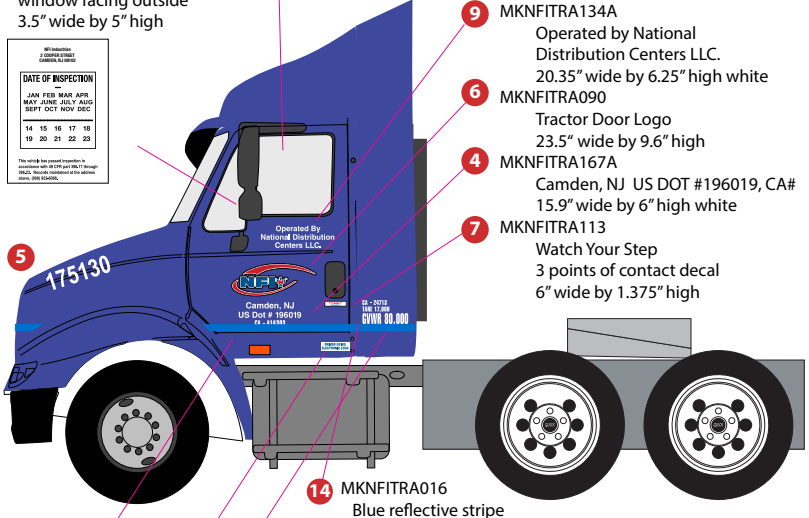

- MKNFITRA134A
Operated by National
Distribution Centers LLC.
20.35" wide by 6.25" high white
- MKNFITRA090
Tractor Door Logo
23.5" wide by 9.6" high
- MKNFITRA167A
Camden, NJ US DOT #196019, CA#
15.9" wide by 6" high white
- MKNFITRA113
Watch Your Step
3 points of contact decal
6" wide by 1.375" high

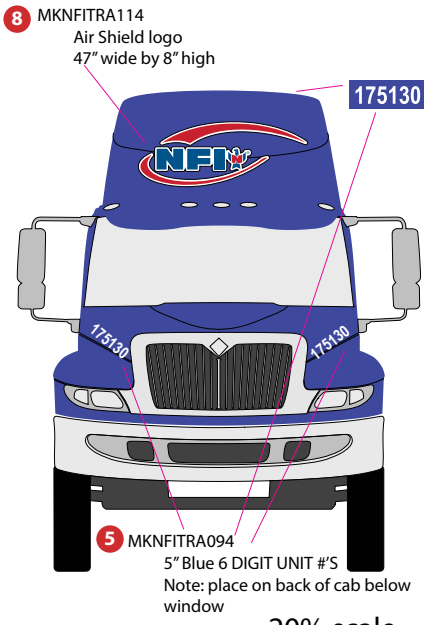

8 MKNFITRA114
Air Shield logo
47" wide by 8" high

5 MKNFITRA094
5" Blue 6 DIGIT UNIT #S
Note: place on back of cab below
window
20% scale

11 MKNFITRA164 -
Tire Check Reminder
2.75" wide by 1.75" high
Placement instruction
sheet attached



13 MKNFITRA180
Electronic Log
8" wide by 2.5" high

PART NUMBER	QTY	DESCRIPTION
1	1	BREAKDOWN SUPPORT DECAL
2	1	DOT INSPECTION Decal
3	2	FUEL PERMIT
4	2	LOCATION/DOT #
5	3	5" WHITE 6 DIGIT UNIT #S
6	2	TRACTOR DOOR LOGO
7	2	WATCH YOUR STEP 3-POINTS
8	1	AIR SHIELD LOGO
9	2	OPERATED BY NDC ...
10	1	NFI CARES DECAL
11	1	TIRE CHECK REMINDER
12	1	DRIVER REMINDER (FOR VISOR)
13	1	ELECTRONIC LOG 8" X 2.5"
14	1	BLUE REFLECTIVE 2" X 25' ROLL



Kit Number MKNFITRA126A

National Distribution Centers

Blue Day Cab Parts

Updated 4-1-2021

- 1** MKNFITRA025 - Breakdown Support Decal
 3.75" wide by 2.75" high
 Blue on white square cut
 Placement in dash



- 2** MKNFITRA026 - DOT Expiration Decal
 3.5" wide by 5" high
 Place on drivers wing window facing outside

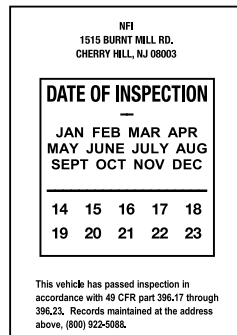

- 3** MKNFITRA089A - NDC Fuel Permit
 12.75" wide by 7.1" high
 White diecut (blue does not print)



- 4** MKNFITRA167A - Location and DOT
 15.9" wide by 6" high
 White diecut (blue does not print)



- 5** MKNFITRL094 - UNIT NUMBER
 5" white 6 digit Unit #'s
 White diecut



- 6** MKNFITRA090 - Tractor Door Decal
 23.5" wide by 9.6" high
 Red and Blue on reflective diecut



Kit Number MKNFITRA126A National Distribution Center Blue Day Cab Parts Updated 4-1-2021

- 7 MKNFITRA113 - Watch your step 3-points of contact
6" wide by 1.375" high
Red and blue on white square cut

**WATCH YOUR STEP
USE 3-POINTS
OF CONTACT**

- 8 MKNFITRA114 - Airshield logo
47" wide by 18" high
Red and Blue on reflective diecut



- 9 MKNFITRL134A- Operated by
National Distribution Centers LLC.
20.35" wide by 6.25" high
White diecut material

**Operated By
National Distribution
Centers LLC.**

- 10 MKNFITRA148 - NFI Cares
7" wide by 2" high
Red and Blue on white square cut
Place on the dashboard

NFI CARES
ONLY use hands free mobile phone utilizing one touch dialing/answering.
Any other mobile device is **PROHIBITED.**
Safety First Stay Alert

- 11 MKNFITRA164 - Tire Check Reminder
2.75" wide by 1.75" high
Green on white square cut
Placement instruction sheet attached

Tire Check Reminder
NFI Standard
Steer Tires = 110 psi
Drive Tires = 100 psi
Trailer Tires = 100 psi
Check Air Pressure Daily
Calibrate Gauge Monthly

- 12 MKNFITRA174 - Driver Reminder
3" wide by 3" high
Black on white square cut
Place on back of
visor inside cab

Attention: NFI Driver
Your tractor is equipped with an
automated Braking and
Lane Departure System.

Please contact your Driver Manager
as soon as possible to review the
System Driver Training video on
My-Learning and/or My-NFI

mylearning@nfindustries.com
www.my-nfi.com

- 13 MKNFITRA180 - Electronic Log
8" wide by 2.5" high
Blue on white
Square cut

**DRIVER USING
ELECTRONIC LOGS**

- 14 MKNFITRA016 - Blue Reflective Stripe
2" high by 25' roll

Kit Number MKNFITRA130 NFI Transportation White Day Cab Kit Updated 4-1-2021

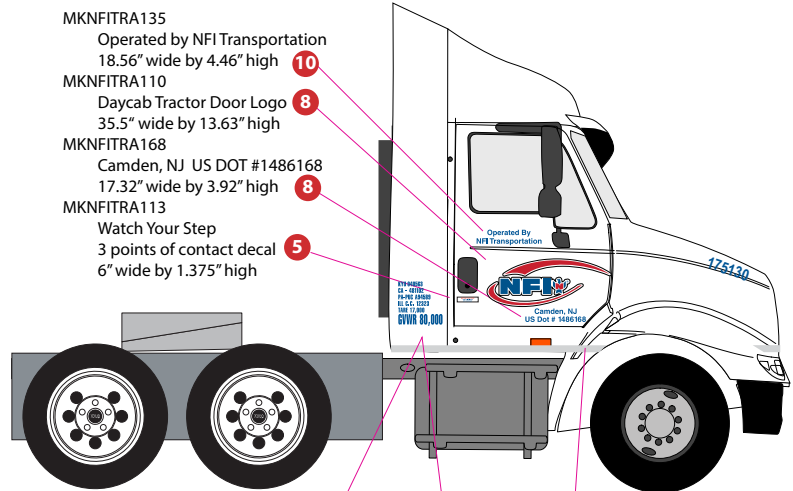

- MKNFITRA135
Operated by NFI Transportation
18.56" wide by 4.46" high **10**
- MKNFITRA110
Daycab Tractor Door Logo
35.5" wide by 13.63" high **8**
- MKNFITRA168
Camden, NJ US DOT #1486168
17.32" wide by 3.92" high **8**
- MKNFITRA113
Watch Your Step
3 points of contact decal
6" wide by 1.375" high **5**

KYU 040563
CA - 481102
PA-PUC A94589
IL C.C. 12323
TARE 17,000
GVWR 80,000

- 1** MKNFITRA015
White reflective stripe

- 2** MKNFITRA025 - Breakdown Support Decal
3.75" wide by 2.75" high
Placement in dash
shown at 50%



- 11** MKNFITRA148 - NFI Cares Decal
7" wide by 2" high
Place on the dashboard



- 13** MKNFITRA174 - Driver Reminder
3" wide by 3" high
Place on the back of the visor inside cab



- 7** MKNFITRA127 National Freight Fuel Permit
12.75" wide by 12.75" high

- 3** MKNFITRA026 - DOT Inspection/Expiration Decal
3.5" wide by 5" high
Place on drivers wing window facing outside



- 6** MKNFITRA114 Air Shield logo
47" wide by 18" high

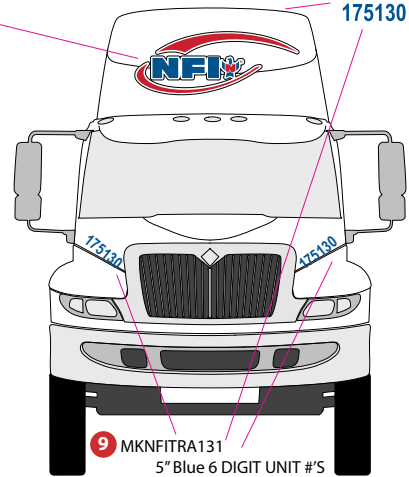

175130

- 1** MKNFITRA015
White reflective stripe

- 14** MKNFITRA181 Electronic Logs
8" wide by 2.5" high



- 7** MKNFITRA127 National Freight Fuel Permit
12.75" wide by 12.75" high

- 12** MKNFITRA164 - Tire Check Reminder
2.75" wide by 1.75" high
Placement instruction sheet attached



- 10** MKNFITRA135
Operated by NFI Transportation
18.56" wide by 4.46" high Blue
- 4** MKNFITRA110
Daycab Tractor Door Logo
35.5" wide by 13.63" high
- 8** MKNFITRA168
Camden, NJ US DOT #1486168
17.32" wide by 3.92" high Blue
- 5** MKNFITRA113
Watch Your Step
3 points of contact decal
6" wide by 1.375" high

- 9** MKNFITRA131
5" Blue 6 DIGIT UNIT #5
Note: place on back of cab below window

20% scale

PART NUMBER QTY DESCRIPTION

PART NUMBER	QTY	DESCRIPTION
1 MKNFITRA015	1	WHITE REFLECTIVE 2" X 25" ROLL
2 MKNFITRA025	1	BREAKDOWN SUPPORT DECAL
3 MKNFITRA026	1	DOT INSPECTION DECAL
4 MKNFITRA110	2	DAYCAB DOOR LOGO
5 MKNFITRA113	2	WATCH YOUR STEP 3-POINTS
6 MKNFITRA114	1	AIR SHIELD LOGO
7 MKNFITRA127	2	FUEL PERMIT
8 MKNFITRA168	2	LOCATION/DOT #
9 MKNFITRA131	3	5" BLUE 6 DIGIT UNIT #5
10 MKNFITRA135	2	OPERATED BY NFI TRANS...
11 MKNFITRA148	1	NFI CARES
12 MKNFITRA164	1	TIRE CHECK REMINDER
13 MKNFITRA174	1	DRIVER REMINDER (FOR VISOR)
14 MKNFITRA181	1	ELECTRONIC LOG



Kit Number MKNFITRA130

NFI Transportation

White Day Cab Parts

Updated 4-1-2021

- 1** MKNFITRA015 - White Reflective
2" x 25'
Place along bottom edge and through front fender

- 2** MKNFITRA025 - Breakdown Support Decal
3.75" wide by 2.75" high
Blue on white square cut
Placement in dash



- 3** MKNFITRA026 - DOT Inspection Decal
3.5" wide by 5" high
Place on drivers wing window facing outside

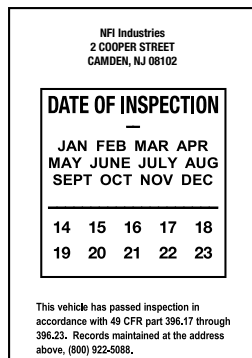

- 4** MKNFITRA110 - Daycab Tractor Door Decal
35.5" wide by 13.63" high
Red and Blue on reflective diecut



- 5** MKNFITRA113 - Watch your step 3-points of contact
6" wide by 1.375" high
Red and blue on white square cut



- 6** MKNFITRA114 - Airshield logo
47" wide by 18" high
Blue and Red on reflective diecut



Kit Number MKNFITRA130

NFI Transportation

White Day Cab Parts

Updated 4-1-2021

- 7** MKNFITRA127 - National Freight Fuel Permit
12.75" wide by 12.75" high
Blue diecut

KYU 040563
CA - 481102
PA-PUC A94589
ILL C.C. 12323
TARE 17,000
GVWR 80,000

- 8** MKNFITRA168 - Location and DOT
17.32" wide by 3.92" high
Blue diecut

Camden, NJ
US Dot # 1486168

- 9** MKNFITRL131 - UNIT NUMBER
5" Blue 6 digit Unit #'s
Blue diecut

0123456789

- 10** MKNFITRL135 - Operated by NFI Transportation
18.56" wide by 4.46" high
Blue diecut

Operated By
NFI Transportation

- 11** MKNFITRA148 - NFI Cares
7" wide by 2" high
Red and blue on white square cut
Place on the dashboard

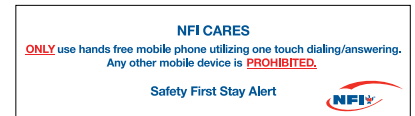

- 12** MKNFITRA164 - Tire Check Reminder
2.75" wide by 1.75" high
Green on white square cut
Placement instruction sheet attached



- 13** MKNFITRA174 - Driver Reminder
3" wide by 3" high
Black on white square cut
Place on the back of the visor inside cab

Attention: NFI Driver
Your tractor is equipped with an
automated Braking and
Lane Departure System.
Please contact your Driver Manager
as soon as possible to review the
System Driver Training video on
MyLearning and/or MyNFI
mylearning@nfiindustries.com
www.mynfi.com

- 14** MKNFITRA181 - Electronic Log decal
8" wide by 2.5" high
Blue on white square cut

DRIVER USING
ELECTRONIC LOGS

Kit Number MKNFITRA130A National Distribution Center White Day Cab Kit 4-1-2021

- 1** MKNFITRA025 - Breakdown Support Decal
3.75" wide by 2.75" high
Placement in dash shown at 50%



- 10** MKNFITRA148 - NFI Cares Decal
7" wide by 2" high
Place on the dashboard



- 2** MKNFITRA026 - DOT Inspection/Expiration Decal
3.5" wide by 5" high
Place on drivers wing window facing outside



- 11** MKNFITRA164 - Tire Check Reminder
2.75" wide by 1.75" high
Placement instruction sheet attached



- 12** MKNFITRA174 - Driver Reminder
3" wide by 3" high
Place on the back of the visor inside cab



- 6** MKNFITRA127A NDC Fuel Permit
12.75" wide by 7.1" high

- 13** MKNFITRA181 Electronic Logs
8" wide by 2.5" high
DRIVER USING ELECTRONIC LOGS

- 14** MKNFITRA015 White reflective stripe

- MKNFITRA135A Operated by National Distribution Centers LLC.
20.35" wide by 6.25" high Blue **9**
- MKNFITRA090 Tractor Door Logo
23.5" wide by 9.6" high **3**
- MKNFITRA168A Camden, NJ US DOT #196019 CA#
15.9" wide by 6" high Blue **7**
- MKNFITRA113 Watch Your Step
3 points of contact decal
6" wide by 1.375" high **4**
- MKNFITRA015 White reflective stripe **15**

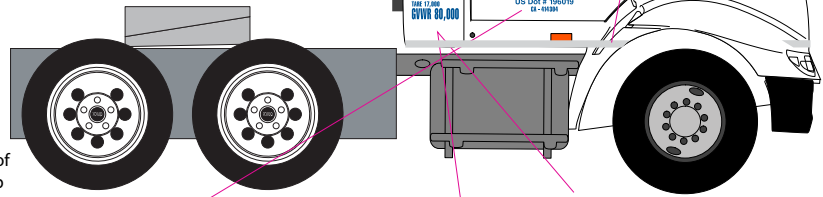

- 7** Camden, NJ
US Dot # 196019
CA - 414304

- MKNFITRA127A NDC Fuel Permit
12.75" wide by 7.1" high **6**

CA - 414304
TARE 17,000
GVWR 80,000

- 5** MKNFITRA114 Air Shield logo
47" wide by 18" high

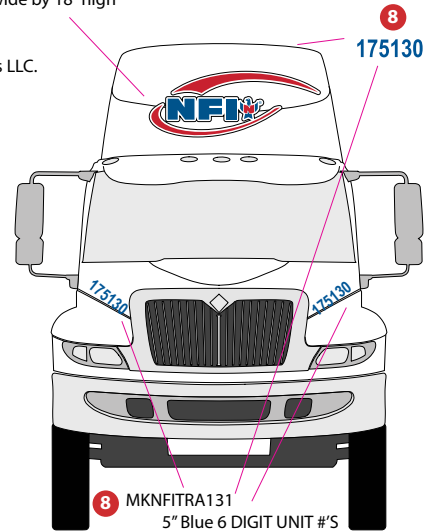

- 8** MKNFITRA131 5" Blue 6 DIGIT UNIT #'S
Note: place on back of cab below window

20% scale

PART NUMBER QTY DESCRIPTION

PART NUMBER	QTY	DESCRIPTION
1 MKNFITRA025	1	BREAKDOWN SUPPORT DECAL
2 MKNFITRA026	1	DOT INSPECTION DECAL
3 MKNFITRA090	2	TRACTOR DOOR LOGO
4 MKNFITRA113	2	WATCH YOUR STEP 3-POINTS
5 MKNFITRA114	1	AIR SHIELD LOGO
6 MKNFITRA127A	2	FUEL PERMIT
7 MKNFITRA168A	2	LOCATION/DOT #
8 MKNFITRA131	3	5" WHITE 6 DIGIT UNIT #'S
9 MKNFITRA135A	2	OPERATED BY NDC ...
10 MKNFITRA148	1	NFI CARES
11 MKNFITRA164	1	TIRE CHECK REMINDER
12 MKNFITRA174	1	DRIVER REMINDER (FOR VISOR)
13 MKNFITRA181	1	ELECTRONIC LOG DECAL
14 MKNFITRA015	1	WHITE REFLECTIVE 2" X 25' ROLL

Kit Number MKNFITRA130A National Distribution Centers White Day Cab Parts Updated 4-1-2021

- 1** MKNFITRA025 - Breakdown Support Decal
3.75" wide by 2.75" high
Blue on white square cut
Placement in dash



- 2** MKNFITRA026 - DOT Inspection Decal
3.5" wide by 5" high
Place on drivers wing window facing outside

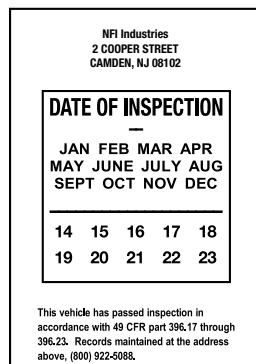

- 3** MKNFITRA090 - Tractor Door Decal
23.5" wide by 9.6" high
Red and Blue diecut on reflective



- 4** MKNFITRA113 - Watch your step 3-points of contact
6" wide by 1.375" high
Red and blue on white squarecut



- 5** MKNFITRA114 - Airshield logo
47" wide by 18" high
Blue and Red on reflective diecut



Kit Number MKNFITRA130A National Distribution Centers White Day Cab Parts Updated 4-1-2021

- 6 MKNFITRA127A - NDC Fuel Permit
12.75" wide by 7.1" high
Blue diecut

CA - 414304
TARE 17,000
GVWR 80,000

- 7 MKNFITRA168A - Location and DOT
15.9" wide by 6" high
Blue diecut

Camden, NJ
US Dot # 196019
CA - 414304

- 8 MKNFITRL131 - UNIT NUMBER
5" Blue 6 digit Unit #'s
Blue diecut

0123456789

- 9 MKNFITRA135A - Operated by
National Distribution Centers
20.35" wide by 6.25" high
Blue diecut

**Operated By
National Distribution
Centers LLC.**

- 10 MKNFITRA148 - NFI Cares
7" wide by 2" high
Blue and red on white square cut
Place on the dashboard

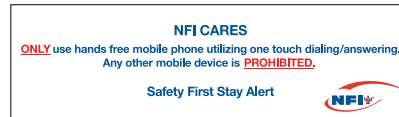

- 11 MKNFITRA164 - Tire Check Reminder
2.75" wide by 1.75" high
Green on white square cut
Placement instruction sheet attached



- 12 MKNFITRA174 - Driver Reminder
3" wide by 3" high
Black on white square cut
Place on the back of the visor
inside cab

Attention: NFI Driver
Your tractor is equipped with an
automated Braking and
Lane Departure System.
Please contact your Driver Manager
as soon as possible to review the
System Driver Training video on
MyLearning and/or MyNFI
www.mynfi.com

- 13 MKNFITRA181 -Electronic Log Decal
8" w by 2.5" h
Blue on white square cut

**DRIVER USING
ELECTRONIC LOGS**

- 14 MKNFITRA015 - White Reflective
2" h by 25' Roll

MKNFITRA142

NFI Transportation

On-Road Yard Truck

Updated 2-7-2020

- 2 MKNFITRA113 - Watch your step
6" wide by 1.375" high
Place on the dashboard

**WATCH YOUR STEP
USE 3-POINTS
OF CONTACT**

- 6 MKNFITRA148 - NFI Cares Decal
7" wide by 2" high
Place on the dashboard

NFI CARES
ONLY use hands free mobile phone while using one touch dialing/answering.
Any other mobile device is PROHIBITED.
Safety First Stay Alert

**KYU 040563
CA - 481102
PA-PUC A94589
ILL C.C. 12323
TARE 17,000
GVWR 80,000**

MKNFITRA135
Operated by NFI Transportation
18.56" wide by 4.46" high
MKNFITRA090
Tractor Door Logo
23.5" wide by 9.6" high
MKNFITRA168
Camden, NJ US DOT #1486168
17.32" wide by 3.92" high Blue Vinyl
MKNFITRA113
Watch your step 3 points of contact decal
6" wide by 1.375" high

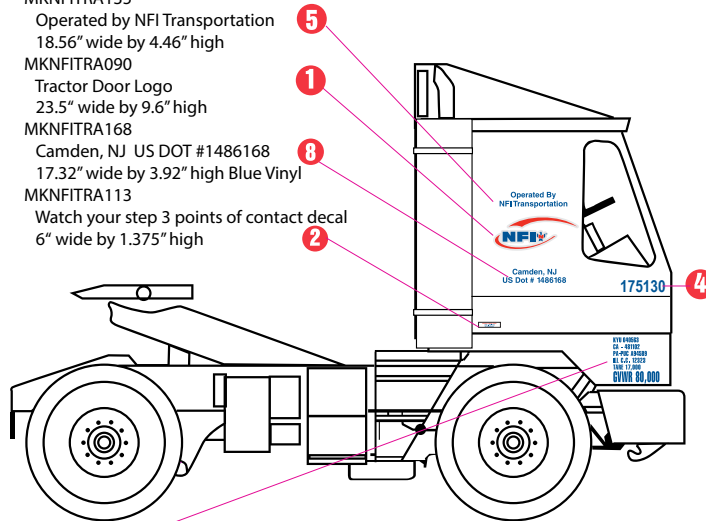

- 3 MKNFITRA127 National Freight
Fuel Permit
12.75" wide by 12.75" high

- 4 MKNFITRA131
5" Blue 6 DIGIT UNIT #'S
Note: place on back of cab

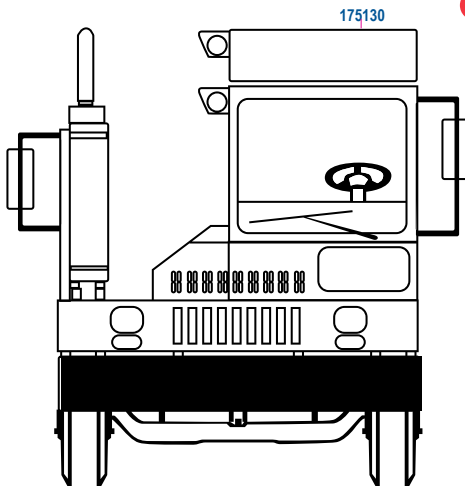

- 3 MKNFITRA127 National Freight
Fuel Permit
12.75" wide by 12.75" high

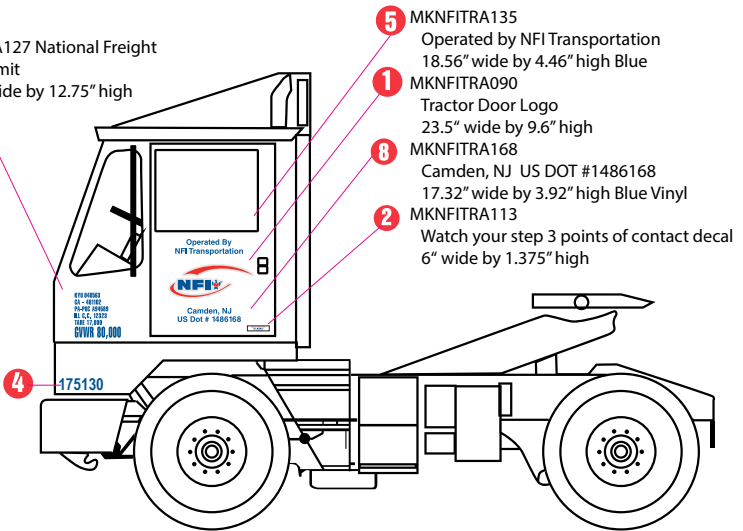

- 5 MKNFITRA135
Operated by NFI Transportation
18.56" wide by 4.46" high Blue
MKNFITRA090
Tractor Door Logo
23.5" wide by 9.6" high
MKNFITRA168
Camden, NJ US DOT #1486168
17.32" wide by 3.92" high Blue Vinyl
MKNFITRA113
Watch your step 3 points of contact decal
6" wide by 1.375" high

- 7 MKNFITRA164 - Tire Check Reminder
2.75" wide by 1.75" high
Placement instruction sheet attached

Tire Check Reminder
NFI Standard
Steer Tires = 110 psi
Drive Tires = 100 psi
Trailer Tires = 100 psi
Check Air Pressure Daily
Calibrate Gauge Monthly

PART NUMBER QTY DESCRIPTION

PART NUMBER	QTY	DESCRIPTION
1	2	MKNFITRA090 TRACTOR DOOR LOGO
2	2	MKNFITRA113 Watch your step 3 points
3	2	MKNFITRA127 FUEL PERMIT
4	3	MKNFITRA131 5" BLUE 6 DIGIT UNIT #'S
5	2	MKNFITRA135 OPERATED BY NFI TRANSP..
6	1	MKNFITRA148 NFI CARES DECAL
7	1	MKNFITRA164 TIRE CHECK DECAL
8	2	MKNFITRA168 LOCATION, US DOT



MKNFITRA143

NFI Transportation

Off-Road Yard Truck

Updated 2-7-2020

- 2** MKNFITRA113 - Watch your step
6" wide by 1.375" high
Place on the dashboard

**WATCH YOUR STEP
USE 3-POINTS
OF CONTACT**

- 6** MKNFITRA164 - Tire Check Reminder
2.75" wide by 1.75" high
Placement instruction sheet attached

Tire Check Reminder
NFI Standard
Steer Tires = 110 psi
Drive Tires = 100 psi
Trailer Tires = 100 psi
Check Air Pressure Daily
Calibrate Gauge Monthly

- 5** MKNFITRA148 - NFI Cares Decal
7" wide by 2" high
Place on the dashboard

NFI CARES
ONLY use hands free mobile phone or ring tone touch dialing/answering.
Any other mobile device is **PROHIBITED**.
Safety First Stay Alert

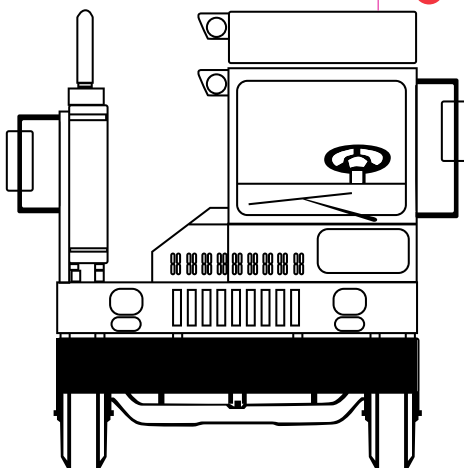

- 3** MKNFITRA131
5" Blue 6 DIGIT UNIT #'S
Note: place on back of cab

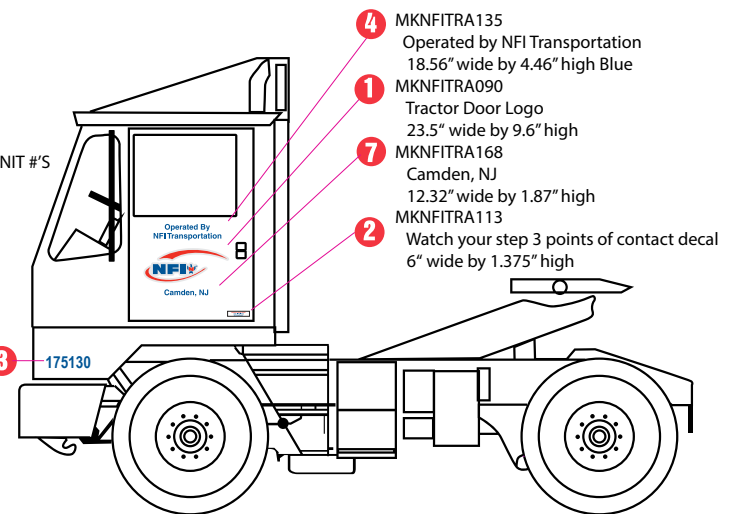
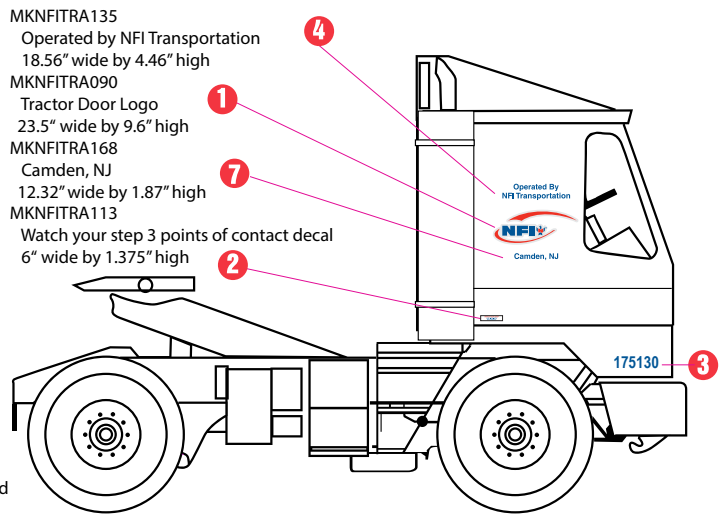

PART NUMBER	QTY	DESCRIPTION	20% scale
1 MKNFITRA090	2	TRACTOR DOOR LOGO	
2 MKNFITRA113	2	Watch your step 3 points	
3 MKNFITRA131	3	5" BLUE 6 DIGIT UNIT #'S	
4 MKNFITRA135	2	OPERATED BY NFI TRANSP...	
5 MKNFITRA148	1	NFI CARES DECAL	
6 MKNFITRA164	1	TIRE CHECK REMINDER	
7 MKNFITRA168	2	LOCATION	



MKNFITRA150

National Distribution Center, LLC

On-Road Yard Truck

Updated 2-7-2020

- 2** MKNFITRA113 - Watch your step
6" wide by 1.375" high
Place on the dashboard

**WATCH YOUR STEP
USE 3-POINTS
OF CONTACT**

- 4** MKNFITRA148 - NFI Cares Decal
7" wide by 2" high
Place on the dashboard



- 6** MKNFITRA164 - Tire Check Reminder
2.75" wide by 1.75" high
Placement instruction sheet attached



MKNFITRA153
Operated by
National Distribution Centers, LLC
Camden, NJ US DOT #196019

MKNFITRA090
Tractor Door Logo
23.5" wide by 9.6" high

MKNFITRA113
Watch your step 3 points of contact decal
6" wide by 1.375" high

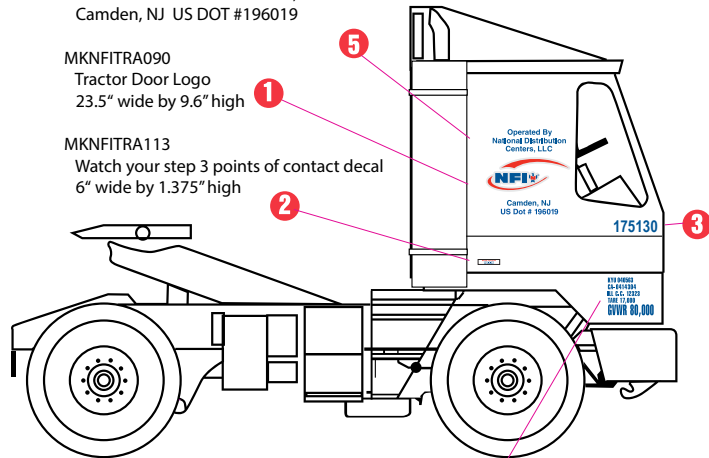

Operated By
National Distribution
Centers, LLC
Camden, NJ
US DOT # 196019

KVU 040593
CA-0414004
N.J. C.C. 12323
TARE 17,000
GVWR 80,000

5 MKNFITRA153 National Freight
Door information and Fuel Permit
20.35" wide by 23.75" high

MKNFITRA131
5" Blue 6 DIGIT UNIT #'S
Note: place on back of cab

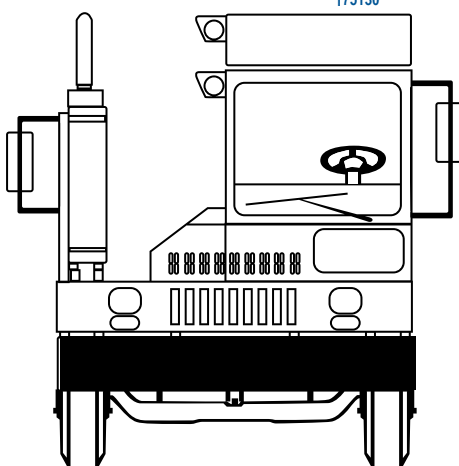

5 MKNFITRA153 National Freight
Fuel Permit

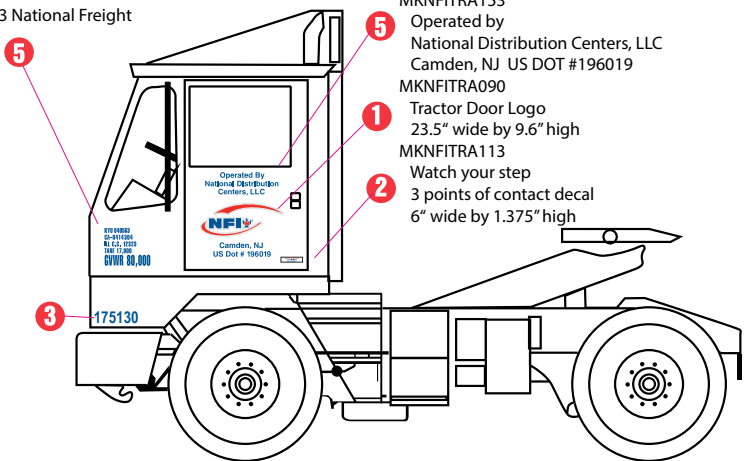

MKNFITRA153
Operated by
National Distribution Centers, LLC
Camden, NJ US DOT #196019

MKNFITRA090
Tractor Door Logo
23.5" wide by 9.6" high

MKNFITRA113
Watch your step
3 points of contact decal
6" wide by 1.375" high

20% scale

PART NUMBER QTY DESCRIPTION

PART NUMBER	QTY	DESCRIPTION
1 MKNFITRA090	2	DOOR LOGO
2 MKNFITRA113	2	Watch your step 3 Points
3 MKNFITRA131	3	5" BLUE 6 DIGIT UNIT #'S
4 MKNFITRA148	1	NFI CARES DECAL
5 MKNFITRA153	2	DOOR INFO/FUEL PERMIT
6 MKNFITRA164	1	TIRE CHECK REMINDER



MKNFITRA151

National Distribution Center, L. P.

Off-Road Yard Truck

Updated 2-7-2020

- 3** MKNFITRA113 - Watch your step
6" wide by 1.375" high
Place on the dashboard
- 5** MKNFITRA149 - Door information
20.35" wide by 8.84" high

**WATCH YOUR STEP
USE 3-POINTS
OF CONTACT**

Operated By
National Distribution
Centers, L.P.
Camden, NJ

- 4** MKNFITRA148 - NFI Cares Decal
7" wide by 2" high
Place on the dashboard

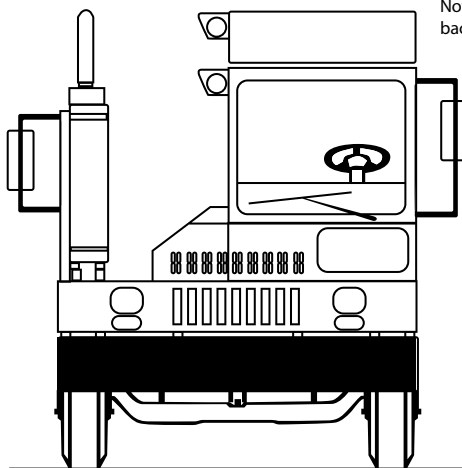

- 3** MKNFITRA131
5" Blue 6 DIGIT UNIT #S
Note: place on
back of cab

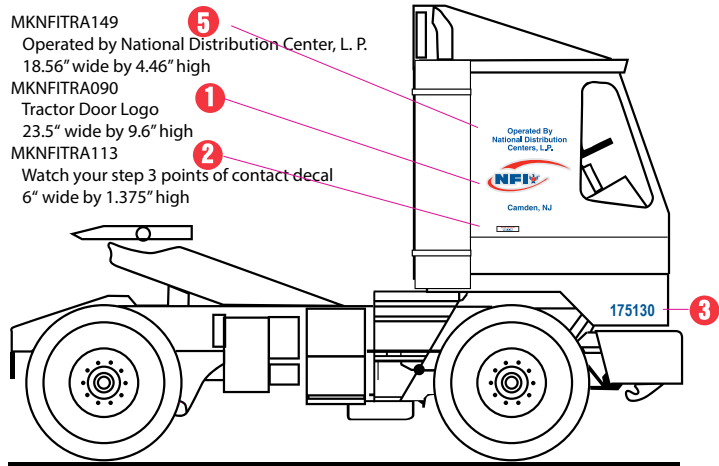

- 5** MKNFITRA149
Operated by National Distribution Center, L. P.
18.56" wide by 4.46" high
- 1** MKNFITRA090
Tractor Door Logo
23.5" wide by 9.6" high
- 2** MKNFITRA113
Watch your step 3 points of contact decal
6" wide by 1.375" high

- 6** MKNFITRA164 - Tire Check Reminder
2.75" wide by 1.75" high
Placement instruction sheet attached

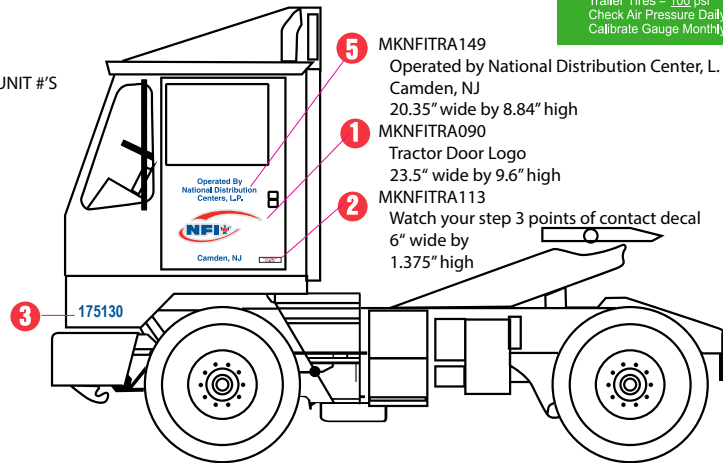

- 5** MKNFITRA149
Operated by National Distribution Center, L. P.
Camden, NJ
20.35" wide by 8.84" high
- 1** MKNFITRA090
Tractor Door Logo
23.5" wide by 9.6" high
- 2** MKNFITRA113
Watch your step 3 points of contact decal
6" wide by
1.375" high

20% scale

PART NUMBER	QTY	DESCRIPTION
1 MKNFITRA090	2	TRACTOR DOOR LOGO
2 MKNFITRA113	2	Watch your step 3 Points
3 MKNFITRA131	3	5" BLUE 6 DIGIT UNIT #S
4 MKNFITRA148	1	NFI CARES DECAL
5 MKNFITRA149	2	Cab Information Blue
6 MKNFITRA164	1	TIRE CHECK REMINDER



MKNFITRA162 Owner Operator Blue Cab Kit

Updated 2-7-2020

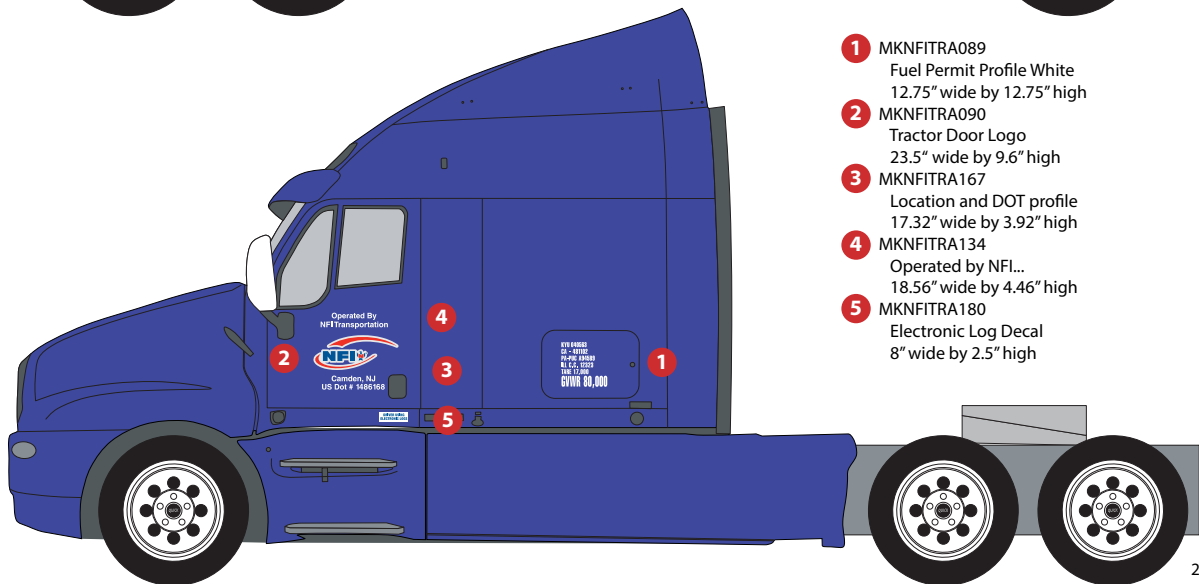
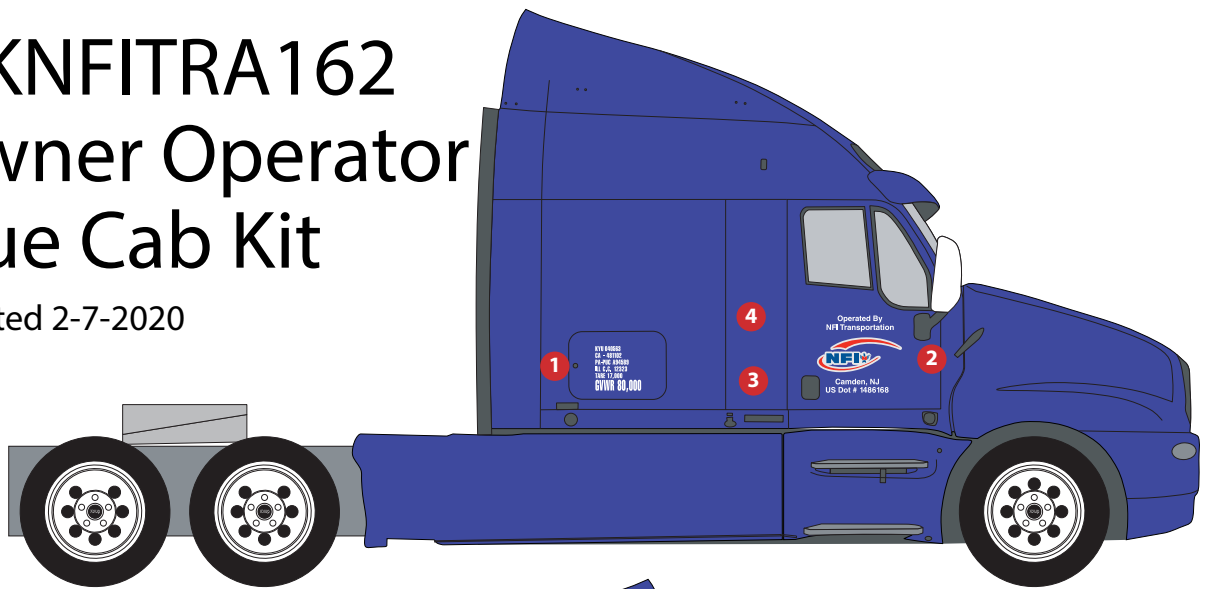

20% scale

- 1 MKNFITRA089
Fuel Permit Profile White
12.75" wide by 12.75" high
- 2 MKNFITRA090
Tractor Door Logo
23.5" wide by 9.6" high
- 3 MKNFITRA167
Location and DOT profile
17.32" wide by 3.92" high
- 4 MKNFITRA134
Operated by NFI...
18.56" wide by 4.46" high
- 5 MKNFITRA180
Electronic Log Decal
8" wide by 2.5" high

PART NUMBER QTY DESCRIPTION

PART NUMBER	QTY	DESCRIPTION
1 MKNFITRA089	2	Fuel Permit Profile White
2 MKNFITRA090	2	Tractor DOOR LOGO
3 MKNFITRA167	2	Camden, NJ US DOT # 1486168
4 MKNFITRA134	2	Operated by NFI Transportation
5 MKNFITRA180	1	Electronic Log decal



Kit Number

MKNFITRA162

NFI Transportation
Owner Operator
Blue Cab Kit Parts
Updated 2-7-2020

- 1 MKNFITRA089 - Fuel Permit Profile White
12.75" wide by 12.75" high
White Profile

KYU 040563
CA - 481102
PA-PUC A94589
ILL C.C. 12323
TARE 17,000
GVWR 80,000

- 2 MKNFITRA090 - Tractor Door Logo
23.5" wide by 9.6" high
Blue and red on reflective
diecut



- 3 MKNFITRA167 - Location and DOT profile
17.32" wide by 3.92" high
White diecut material
(note, blue is the color of the vehicle and
isn't included in this part)

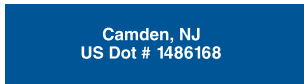

- 4 MKNFITRA134 -
Operated By NFI Transportation
18.56" by 4.46" White diecut



- 5 MKNFITRA180 -
Electronic Log Decal
8" by 2.5" squarecut

**DRIVER USING
ELECTRONIC LOGS**

MKNFITRA163 Owner Operator White Cab Kit

Updated 2-7-2020

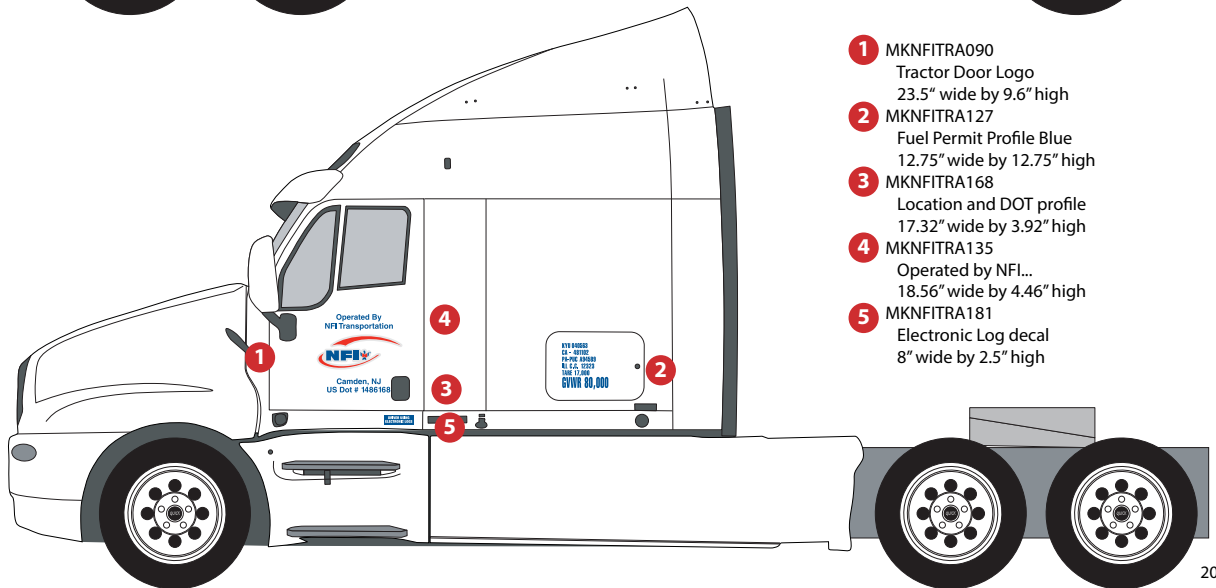
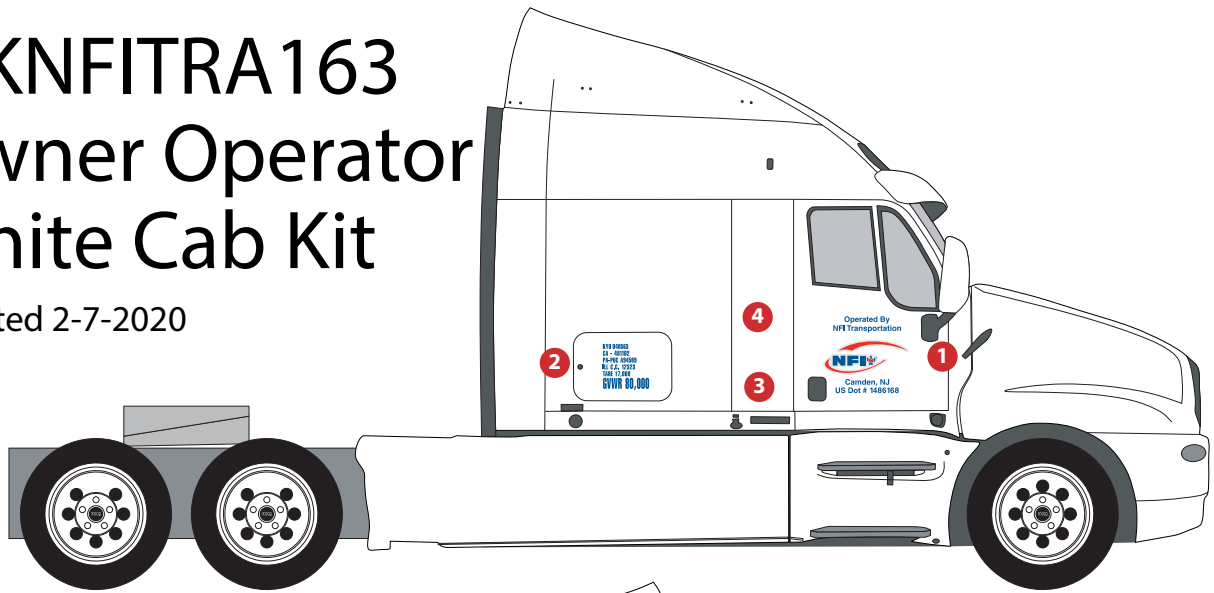

20% scale

- 1 MKNFITRA090
Tractor Door Logo
23.5" wide by 9.6" high
- 2 MKNFITRA127
Fuel Permit Profile Blue
12.75" wide by 12.75" high
- 3 MKNFITRA168
Location and DOT profile
17.32" wide by 3.92" high
- 4 MKNFITRA135
Operated by NFI...
18.56" wide by 4.46" high
- 5 MKNFITRA181
Electronic Log decal
8" wide by 2.5" high

	PART NUMBER	QTY	DESCRIPTION
1	MKNFITRA090	2	Tractor DOOR LOGO
2	MKNFITRA127	2	Fuel Permit Profile Blue
3	MKNFITRA168	2	Camden, NJ US DOT # 1486168
4	MKNFITRA135	2	Operated by NFI Transportation
5	MKNFITRA181	1	Electronic Log decal



Kit Number

MKNFITRA163

NFI Transportation
Owner Operator
White Cab Kit Parts
Updated 2-7-2020

- 5 MKNFITRA181 -
Electronic Log decal
8" by 2.5" Blue

**DRIVER USING
ELECTRONIC LOGS**

- 1 MKNFITRA090 - Tractor Door Logo
23.5" wide by 9.6" high
Blue and red on reflective
diecut



- 2 MKNFITRA168 - Fuel Permit Profile Blue
12.75" wide by 12.75" high
Blue profile

KYU 040563
CA - 481102
PA-PUC A94589
ILL. C.C. 12323
TARE 17,000
GVWR 80,000

- 3 MKNFITRA168 - Location and DOT profile
17.32" wide by 3.92" high
Blue diecut material
(note, white is the color of the vehicle and
isn't included in this part)

Camden, NJ
US Dot # 1486168

- 4 MKNFITRA135 -
Operated By NFI Transportation
18.56" by 4.46" Blue diecut

Operated By
NFI Transportation



MKNFITRA173 Owner Operator Cab Kit

Updated 2-7-2020

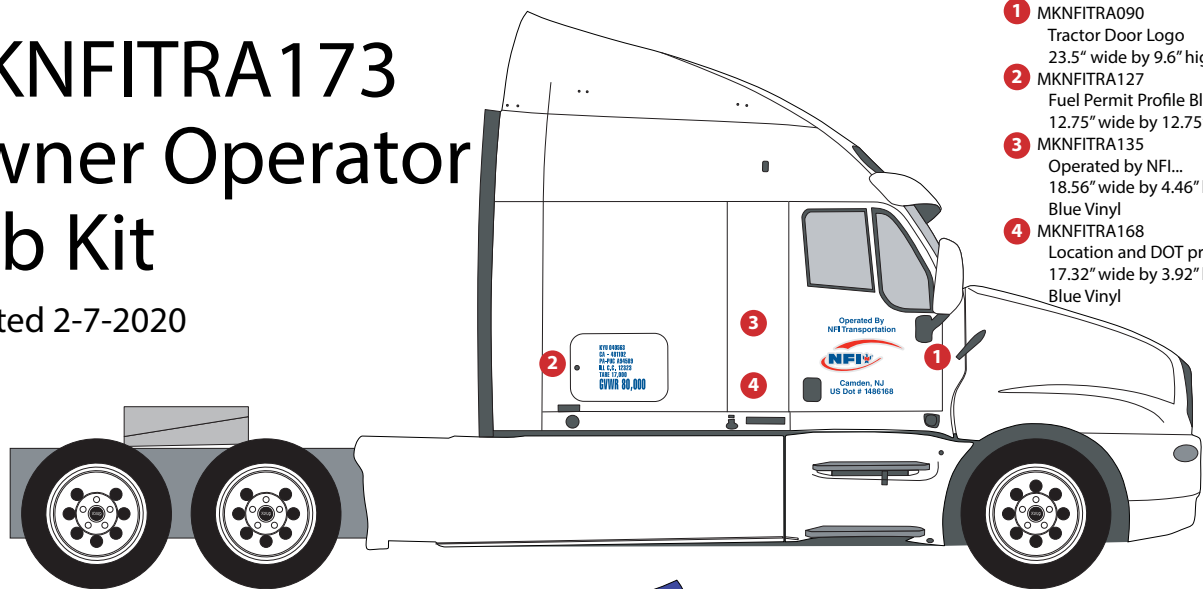

- 1 MKNFITRA090
Tractor Door Logo
23.5" wide by 9.6" high
- 2 MKNFITRA127
Fuel Permit Profile Blue Vinyl
12.75" wide by 12.75" high
- 3 MKNFITRA135
Operated by NFI...
18.56" wide by 4.46" high
Blue Vinyl
- 4 MKNFITRA168
Location and DOT profile
17.32" wide by 3.92" high
Blue Vinyl

Note: If the cab is light, use the blue vinyl markings as indicated.

- 8 MKNFITRA180 for use on blue trucks

**DRIVER USING
ELECTRONIC LOGS**

- 9 MKNFITRA181 for use on white trucks

**DRIVER USING
ELECTRONIC LOGS**

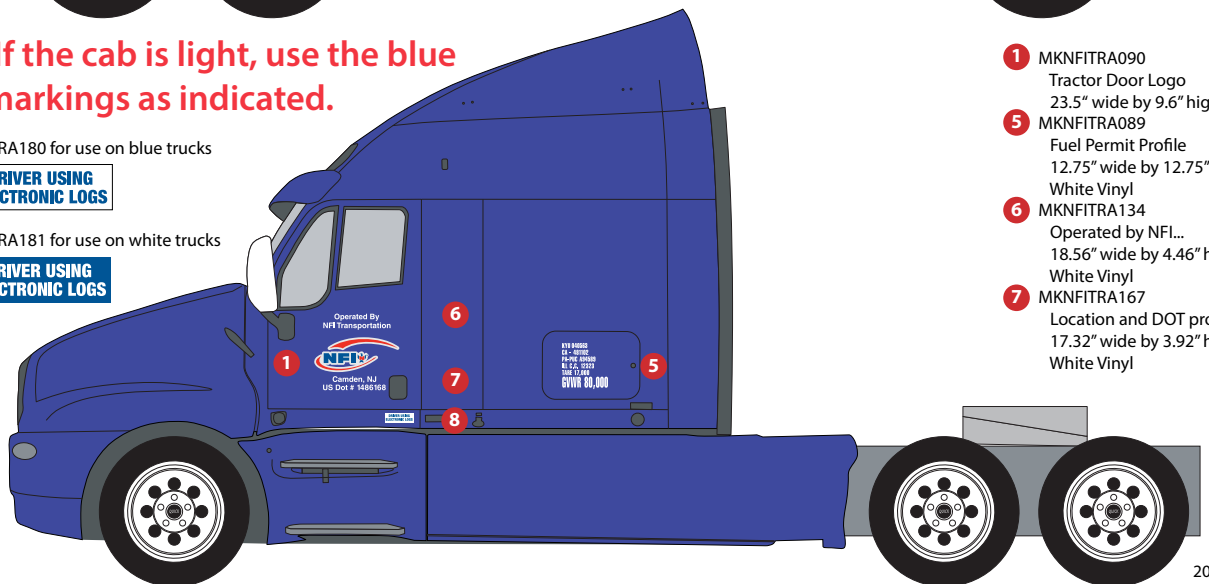

- 1 MKNFITRA090
Tractor Door Logo
23.5" wide by 9.6" high
- 5 MKNFITRA089
Fuel Permit Profile
12.75" wide by 12.75" high
White Vinyl
- 6 MKNFITRA134
Operated by NFI...
18.56" wide by 4.46" high
White Vinyl
- 7 MKNFITRA167
Location and DOT profile
17.32" wide by 3.92" high
White Vinyl

20% scale

Note: If the cab is dark use the white vinyl markings.

PART NUMBER QTY DESCRIPTION

<u>PART NUMBER</u>	<u>QTY</u>	<u>DESCRIPTION</u>
1 MKNFITRA090	2	Tractor DOOR LOGO
2 MKNFITRA127	2	Fuel Permit Profile Blue Vinyl
3 MKNFITRA168	2	Location, US DOT Blue Vinyl
4 MKNFITRA135	2	Operated by NFI... Blue Vinyl
5 MKNFITRA089	2	Fuel Permit Profile White Vinyl
6 MKNFITRA134	2	Operated by NFI... White Vinyl
7 MKNFITRA167	2	Location, US DOT White Vinyl
8 MKNFITRA180	1	Electronic Log for blue cab
9 MKNFITRA181	1	Electronic log for white cab

vernon
GRAPHIC SOLUTIONS
digital & screen printing

vernon
GRAPHIC SOLUTIONS
digital & screen printing

Kit Number MKNFITRA173

National Freight Owner Operator Cab Kit Parts

Updated 2-7-2020

- 1** MKNFITRA090 - Tractor Door Logo
23.5" wide by 9.6" high
Blue and red on reflective diecut



- 2** MKNFITRA127 - Fuel Permit Profile Blue
12.75" wide by 12.75" high
Blue diecut vinyl

**KYU 040563
CA - 481102
PA-PUC A94589
ILL C.C. 12323
TARE 17,000
GVWR 80,000**

- 3** MKNFITRA135 - Operated By NFI Transportation
18.56" by 4.46" Blue diecut vinyl

**Operated By
NFI Transportation**

- 4** MKNFITRA168 - Location and DOT profile
17.32" wide by 3.92" high
Blue diecut vinyl
(note, white is the color of the vehicle and isn't included in this part)

**Camden, NJ
US Dot # 1486168**

- 5** MKNFITRA089 - Fuel Permit Profile white
12.75" wide by 12.75" high
White diecut vinyl

**KYU 040563
CA - 481102
PA-PUC A94589
ILL C.C. 12323
TARE 17,000
GVWR 80,000**

- 6** MKNFITRA134 - Operated By NFI Transportation
18.56" by 4.46" White diecut vinyl

**Operated By
NFI Transportation**

- 7** MKNFITRA167 - Location and DOT profile
17.32" wide by 3.92" high
White diecut vinyl

**Camden, NJ
US Dot # 1486168**

- 8** MKNFITRA180 - Electronic Log
18" wide by 2.5" high for use on blue cabs
Square Cut

**DRIVER USING
ELECTRONIC LOGS**

- 9** MKNFITRA181 - Electronic Log
18" wide by 2.5" high for use on white cabs
Square Cut

**DRIVER USING
ELECTRONIC LOGS**

Kit Number

MKNFITRA100C

NFI Canada Blue Sleeper Cab Kit
Updated 4-1-2021

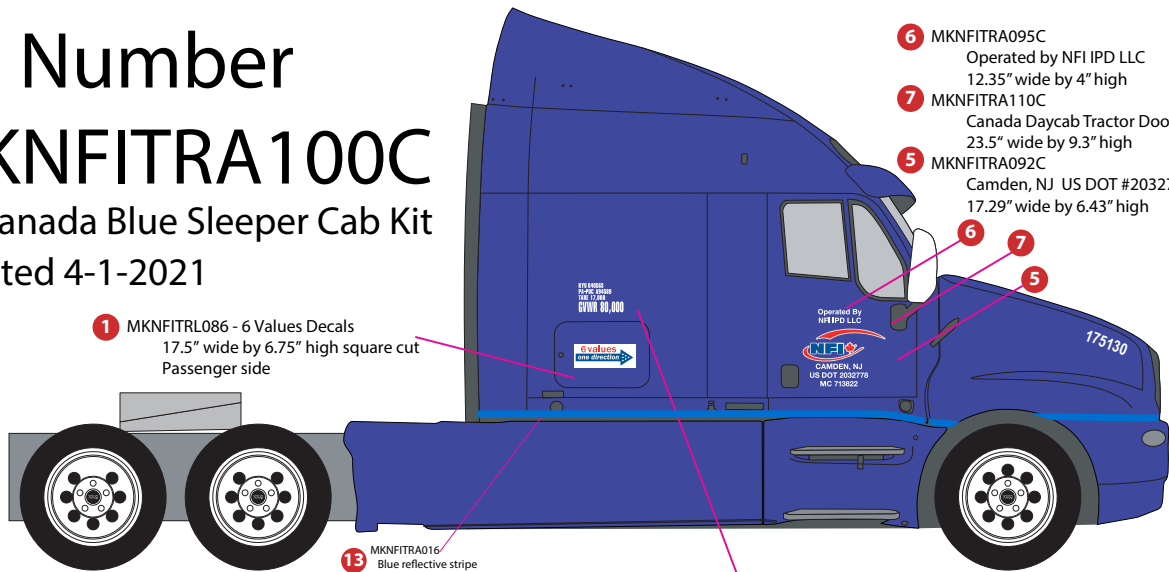

1 MKNFITRL086 - 6 Values Decals
17.5" wide by 6.75" high square cut
Passenger side

13 MKNFITRA016
Blue reflective stripe

- 6** MKNFITRA095C
Operated by NFI IPD LLC
12.35" wide by 4" high
- 7** MKNFITRA110C
Canada Daycab Tractor Door Logo
23.5" wide by 9.3" high
- 5** MKNFITRA092C
Camden, NJ US DOT #2032778
17.29" wide by 6.43" high

- 6** MKNFITRA095C
Operated by NFI IPD LLC
12.35" wide by 4" high
- 7** MKNFITRA110C
Canada Daycab Tractor Door Logo
23.5" wide by 9.3" high
- 5** MKNFITRA092C
Camden, NJ US DOT #2032778
17.29" wide by 6.43" high

Fuel Permit as profile
with no dot#
Shown at 50% of original
12.75" w by 8.78" h
Background color of blue does
not print, is there to show the white
profile cut lette rs.

KYU 040563
PA-PUC A94589
TARE 17,000
GVWR 80,000

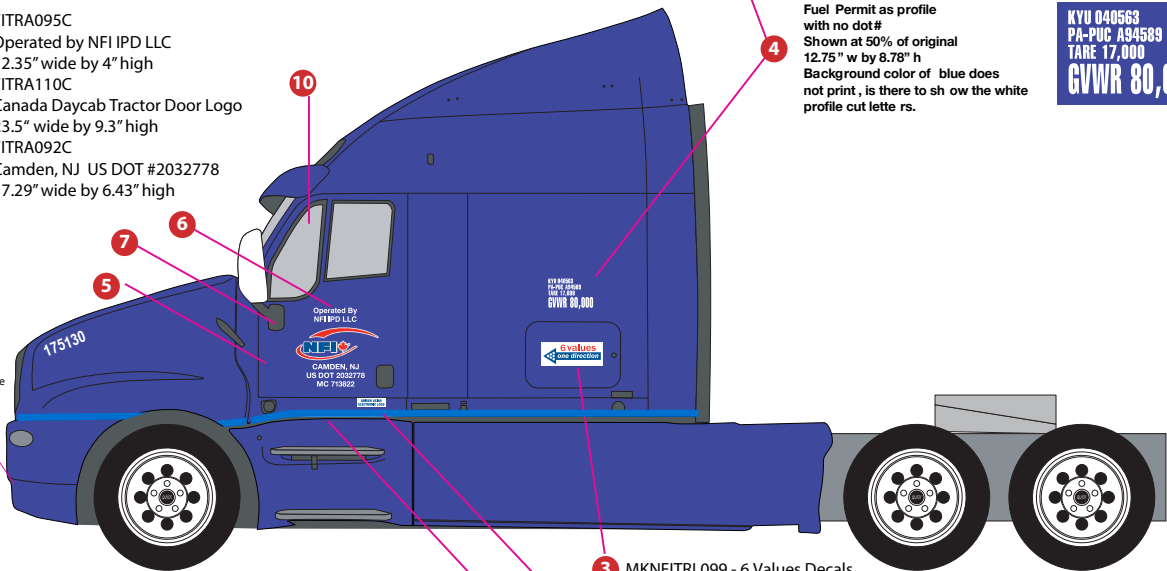

12 MKNFITRA016
Blue reflective stripe

8 MKNFITRA114C
NEW Air Shield logo
47" wide by 18.66" high

10 MKNFITRA174 -
Driver Reminder
3" wide by 3" high
Place on the back of
the visor inside cab

3 MKNFITRL099 - 6 Values Decals
17.5" wide by 6.75" high square cut
Drivers side

11 MKNFITRA180 - Electronic Logs
8" wide by 2.5" high

9 MKNFITRA164 - Tire Check Reminder
2.75" wide by 1.75" high
Placement instruction sheet attached

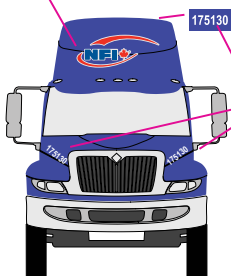

2 MKNFITRA094
5" 6 DIGIT UNIT #'S WHITE
Note: place on back of cab below
window

Attention: NFI Driver
Your vehicle is equipped with an
automated braking and
Lane Departure System.
Please contact your Driver Manager
as soon as possible to review the
System Driver Training video on
MyLearning and/or MyNFI
mylearning@nfitruck.com
www.nfi.com

NFI Tire Check Reminder
NFI Standard
Steer Tires = 110 psi
Drive Tires = 100 psi
Trailer Tires = 100 psi
Check Air Pressure Daily
Calibrate Gauge Monthly

PART NUMBER	QTY	DESCRIPTION
1 MKNFITRL086	1	6 VALUES DECAL PASSENGER
2 MKNFITRA094	3	5" WHITE 6 DIGIT UNIT #'S
3 MKNFITRL099	1	6 VALUES DECAL DRIVERS
4 MKNFITRA089C	2	CANADA FUEL PERMIT
5 MKNFITRA092C	2	LOCATION/DOT #/ MC
6 MKNFITRA095C	2	OPERATED BY + NFI IPD LLC
7 MKNFITRA110C	2	CANADA CAB DOOR LOGO
8 MKNFITRA114C	1	CANADA AIR SHIELD LOGO
9 MKNFITRA164	1	TIRE CHECK REMINDER
10 MKNFITRA174	1	DRIVER REMINDER (FOR VISOR)
11 MKNFITRA180	1	ELECTRONIC LOG 8" X 2.5"
12 MKNFITRA016	1	BLUE REFLECTIVE 2" X 25' ROLL



Kit Number

MKNFITRA100C

NFI Canada Blue Sleeper Cab Kit Parts

Updated 4-1-2021

- 1** MKNFITRL086 - 6 Values Decals
17.5" wide by 6.75" high
Red and blue on white square cut
Passenger side



- 2** MKNFITRL094 - UNIT NUMBER
5" White 6 digit Unit #'s
Diecut material

0123456789

- 3** MKNFITRL099 - 6 Values Decals
17.5" wide by 6.75" high
Red and Blue on white square cut
Driver side



- 4** MKNFITRA089C - Canada Fuel Permit
12.75" by 8.78"
White diecut

KYU 040563
PA-PUC A94589
TARE 17,000
GVWR 80,000

- 5** MKNFITRA092C - Canada Location, DOT & MC
17.28" wide by 6.4" high
Diecut on white material
Note blue indicates the color of vehicle
and does not print

CAMDEN, NJ
US DOT 2032778
MC 713822

- 6** MKNFITRA095C -
Operated By NFI IPD LLC
12.35" by 4.05" White diecut

Operated By
NFI IPD LLC

- 7** MKNFITRA110C - Canada Tractor Door Logo
23.5" wide by 9.33" high
Red and blue on reflective diecut



- 8** MKNFITRA114C - Canada Air Shield Logo
47" wide by 18.66" high
Red and Blue on reflective diecut



- 9** MKNFITRA164 - Tire Check Reminder
2.75" wide by 1.75" high
Green on white square cut
Placement instruction
sheet attached



- 10** MKNFITRA174 - Driver Reminder
3" wide by 3" high
Black on white square cut
Place on the back of the visor
inside cab

Attention: NFI Driver
Your tractor is equipped with an
automated braking and
Lane Departure System.
Please contact your Driver Manager
as soon as possible to review the
System Driver Training video on
Viz Learning and/or MyNFI
mykaming@nfiindustries.com
www.mynfi.com

- 11** MKNFITRA180 - Electronic Log Decal
8" wide by 2.5" high
Blue on white square cut

DRIVER USING
ELECTRONIC LOGS

- 12** MKNFITRA016 - Blue Reflective Stripe
2" high by 25' roll

Kit Number MKNFITRA105C

NFI Canada White Sleeper Cab Kit
Updated 4-1-2021

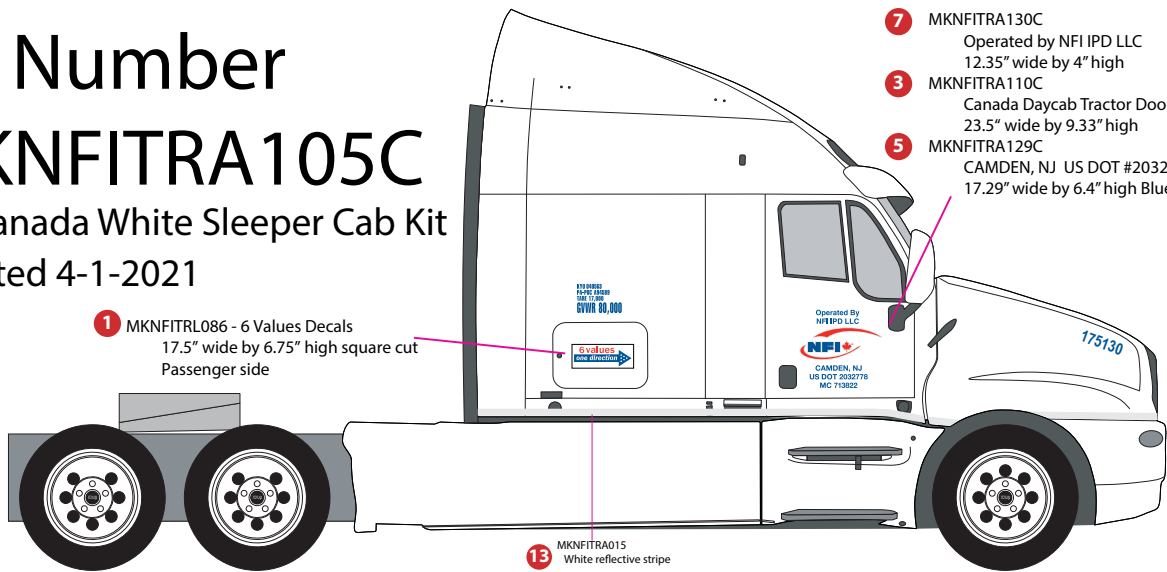

1 MKNFITRL086 - 6 Values Decals
17.5" wide by 6.75" high square cut
Passenger side

7 MKNFITRA130C
Operated by NFI IPD LLC
12.35" wide by 4" high
3 MKNFITRA110C
Canada Daycab Tractor Door Logo
23.5" wide by 9.33" high
5 MKNFITRA129C
CAMDEN, NJ US DOT #2032778
17.29" wide by 6.4" high Blue

13 MKNFITRA015
White reflective stripe

8
Fuel Permit as p profile
with no dot#
Shown at 50% of original
12.75" w by 8.78" h

KYU 040563
PA-PUC A94589
TARE 17,000
GVWR 80,000

7 MKNFITRA0130C
Operated by NFI IPD LLC
12.35" wide by 4" high Blue
3 MKNFITRA110C
Canada Daycab Tractor Door Logo
23.5" wide by 9.33" high
5 MKNFITRA129C
CAMDEN, NJ US DOT #2032778
17.29" wide by 6.4" high Blue

10 MKNFITRA174 -
Driver Reminder
3" wide by 3" high
Place on the back of
the visor inside cab

Attention: All Driver
Reminders are equipped with an
automatic Blowing and
Lane Departure System.
Please contact your Driver Manager
to view or update the system
system Driver Training and/or
Maintenance and/or Audit.
nfi@regionalbusiness.com
www.nfi.com

12
MKNFITRA015
White reflective stripe

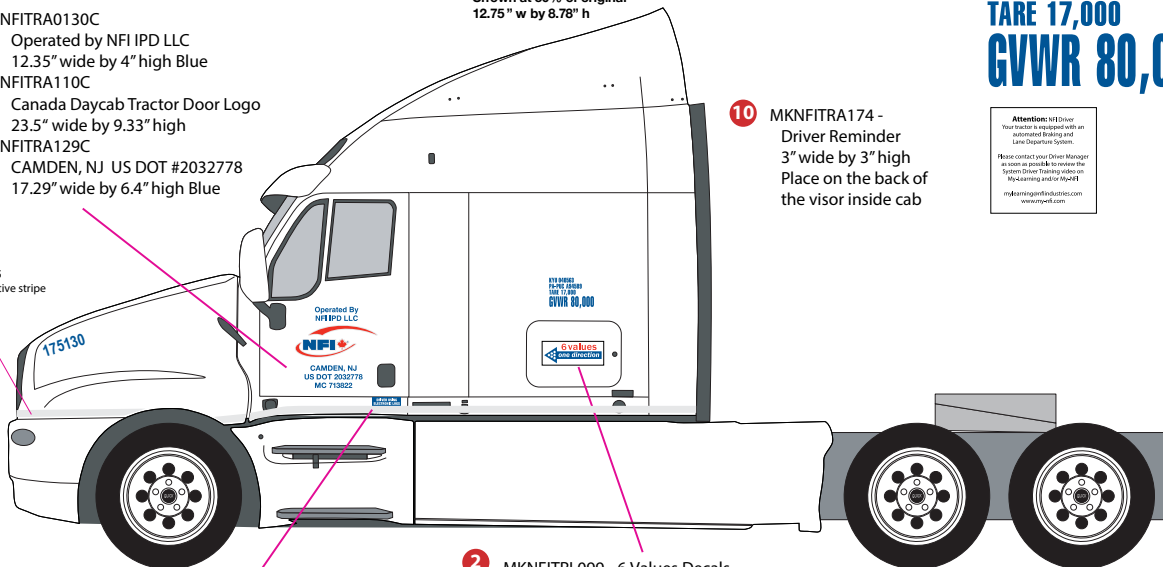

2 MKNFITRL099 - 6 Values Decals
17.5" wide by 6.75" high square cut
Drivers side

9 MKNFITRA164 - Tire Check Reminder
2.75" wide by 1.75" high
Placement instruction sheet attached

NFI Tire Check Reminder
NFI Standard
Steer Tires = 110 psi
Drive Tires = 100 psi
Trailer Tires = 100 psi
Check Air Pressure Daily
Calibrate Gauge Monthly

4
MKNFITRA114C
Air Shield logo
47" wide by 18.66" high

11 MKNFITRA181 -
Electronic Log
8" wide by 2.5" high

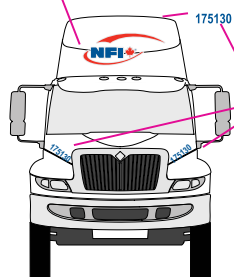

6
MKNFITRA131
5" 6 DIGIT UNIT #S BLUE
Note: place on back of cab below
window

PART NUMBER QTY DESCRIPTION

PART NUMBER	QTY	DESCRIPTION
1 MKNFITRL086	1	6 VALUES DECAL PASSENGER
2 MKNFITRL099	1	6 VALUES DECAL DRIVERS
3 MKNFITRA110C	2	CANADA CAB DOOR LOGO
4 MKNFITRA114C	1	CANADA AIR SHIELD LOGO
5 MKNFITRA129C	2	CAMDEN, NJ, DOT, MC
6 MKNFITRA131	2	5" WHITE 6 DIGIT UNIT #S
7 MKNFITRA130C	2	OPERATED BY + NFI IPD LLC BLUE
8 MKNFITRA134C	2	CANADA FUEL PERMIT
9 MKNFITRA164	1	TIRE CHECK REMINDER
10 MKNFITRA174	1	DRIVER REMINDER (FOR VISOR)
11 MKNFITRA181	1	ELECTRONIC LOG 8" X 2.5"
12 MKNFITRA015	1	WHITE REFLECTIVE 2" X 25' ROLL

vernon
GRAPHIC SOLUTIONS
digital & screen printing

Kit Number

MKNFITRA105C

NFI Canada White Sleeper Cab Kit Parts

Updated 4-1-2021

- 1 MKNFITRL086 - 6 Values Decals Passengers
17.5" wide by 6.75" high
Red and blue on white
Square cut



- 2 MKNFITRL114C - Canada Air Shield Logo
47" wide by 18.66" high
Red and Blue on reflective diecut



- 3 MKNFITRA134C - Canada Fuel Permit
12.75" by 8.78"
Blue diecut

KYU 040563
PA-PUC A94589
TARE 17,000
GVWR 80,000

- 4 MKNFITRL110C - Tractor DoorLogo
23.5" wide by 9.33" high
Red and Blue on reflective diecut



- 5 MKNFITRA129C - Canada Location, DOT & MC
17.29" wide by 6.4" high
Diecut Blue material

CAMDEN, NJ
US DOT 2032778
MC 713822

- 6 MKNFITRL131 - UNIT NUMBER
5" Blue 6 digit Unit #'s
Diecut material

0123456789

- 7 MKNFITRA130C -
Operated By NFI IPD LLC **Operated By**
12.35" by 4.05" Blue diecut **NFI IPD LLC**

- 8 MKNFITRL099 - 6 Values Decals
17.5" wide by 6.75" high
Red and blue on white square cut
Driver side



- 9 MKNFITRA164 - Tire Check Reminder
2.75" wide by 1.75" high
Green on white square cut
Placement instruction sheet attached



- 10 MKNFITRA174 - Driver Reminder
3" wide by 3" high
Black on white square cut
Place on the back of the visor
inside cab



- 11 MKNFITRA181 - Electronic Log
8" wide by 2.5" high
Blue on white
Square cut



- 12 MKNFITRA015 - White Reflective stripe
2" x 25" roll



Kit Number

MKNFITRA125C

NFI Canada White Day Cab Kit
Updated 4-1-2021

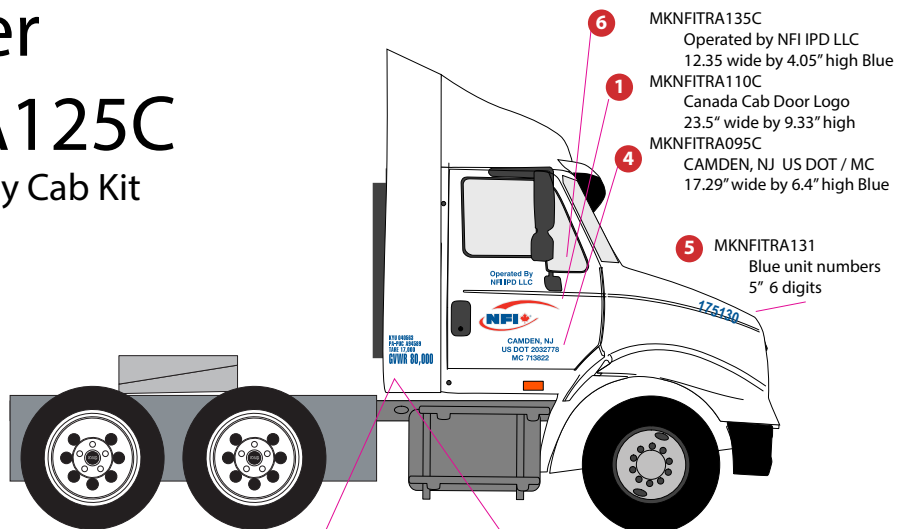

- 6 MKNFITRA135C
Operated by NFI IPD LLC
12.35 wide by 4.05" high Blue
- 1 MKNFITRA110C
Canada Cab Door Logo
23.5" wide by 9.33" high
- 4 MKNFITRA095C
CAMDEN, NJ US DOT / MC
17.29" wide by 6.4" high Blue
- 5 MKNFITRA131
Blue unit numbers
5" 6 digits

- 8 MKNFITRA174 -
Driver Reminder
3" wide by 3" high
Place on the back of
the visor inside cab
- 3 MKNFITRA127C NFI Canada
Fuel Permit in blue
12.75" wide by 8.78" high

Attention: HD Driver
Your truck is equipped with an
automated braking and
Lane Departure System.
Please contact your Driver Manager
as soon as possible to receive the
System Driver Training video on
the company intranet at
mknfitra@nfi.com
www.nfi.com

- 5 MKNFITRA131
Blue unit numbers
5" 6 digits

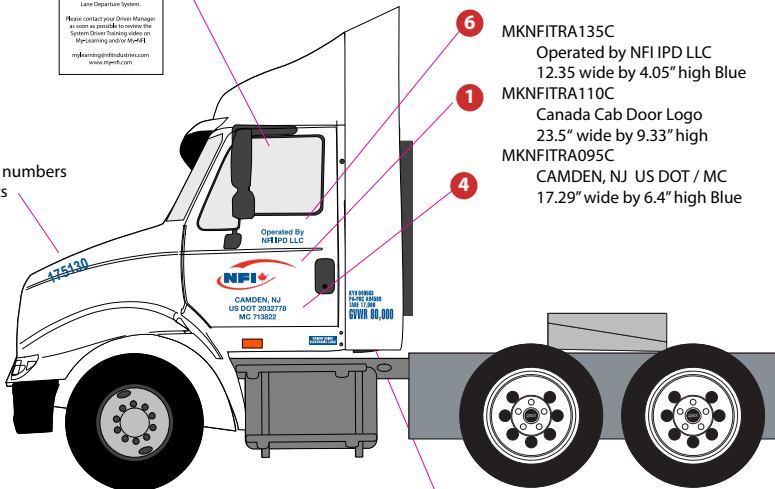

- 6 MKNFITRA135C
Operated by NFI IPD LLC
12.35 wide by 4.05" high Blue
- 1 MKNFITRA110C
Canada Cab Door Logo
23.5" wide by 9.33" high
- 4 MKNFITRA095C
CAMDEN, NJ US DOT / MC
17.29" wide by 6.4" high Blue

3 **KYU 040563**
PA-PUC A94589
TARE 17,000
GVWR 80,000

- 2 MKNFITRA114C
Canada Air Shield logo
47" wide by 18.66 high
- 9 MKNFITRA181 -
Electronic Logs
8" wide by 2.5" high

- 3 MKNFITRA127C NFI Canada
Fuel Permit in blue
12.75" wide by 8.78" high

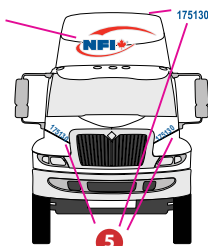

- 5 MKNFITRA131
5" Blue 6 DIGIT UNIT #S
Note: place on back of cab below
window

- 7 MKNFITRA164 - Tire Check Reminder
2.75" wide by 1.75" high
Placement instruction sheet attached

Tire Check Reminder
NFI Standard
Steer Tires = 110 psi
Drive Tires = 100 psi
Trailer Tires = 100 psi
Check Air Pressure Daily
Calibrate Gauge Monthly

20% scale

PART NUMBER QTY DESCRIPTION

PART NUMBER	QTY	DESCRIPTION
1	2	CANADA CAB DOOR LOGO
2	1	CANADA AIR SHIELD LOGO
3	2	CANADA FUEL PERMIT
4	2	CAMDEN, NJ, DOT, MC BLUE
5	3	5" BLUE 6 DIGIT UNIT #S
6	2	OPERATED BY + NFI IPD LLC BLUE
7	1	TIRE CHECK REMINDER
8	1	DRIVER REMINDER (FOR VISOR)
9	1	ELECTRONIC LOG



Kit Number MKNFITRA125C NFI Canada White Day Cab Parts

Updated 4-1-2021

- 1 MKNFITRA110C - Canada Cab Door Decal
23.5" wide by 9.33" high
Red and Blue diecut on reflective



- 2 MKNFITRA114C - NFI Canada Airshield logo
47" wide by 18.66" high
Red and Blue diecut on reflective



- 3 MKNFITRA134C - Canada Fuel Permit
12.75" by 8.78"
Blue diecut

**KYU 040563
PA-PUC A94589
TARE 17,000
GVWR 80,000**

- 4 MKNFITRA095C - Canada Location, DOT, MC
17.29" wide by 6.4" high
Diecut blue material

**CAMDEN, NJ
US DOT 2032778
MC 713822**

- 5 MKNFITRL131 - UNIT NUMBER
5" 6 digit Unit #'s
Diecut blue material

0123456789

- 6 MKNFITRL130C- Operated by NFI IPD LLC
2.35" wide by 4.05" high
Blue diecut material

Operated By NFI IPD LLC

- 7 MKNFITRA164 - Tire Check Reminder
2.75" wide by 1.75" high
Placement instruction sheet attached



- 8 MKNFITRA174 - Driver Reminder
3" wide by 3" high
Place on the back of the visor
inside cab

Attention: NFI Driver
Your tractor is equipped with an
automated braking and
Lane Departure System.
Please contact your Driver Manager
as soon as possible to review the
System Driver Training videos on
MyLearning and/or the NFI
mylearning@nfiindustries.com
www.nfi.com

- 9 MKNFITRA181 - Long Stroke Brake
8" wide by 2.5" high square cut

**DRIVER USING
ELECTRONIC LOGS**



Kit Number MKNFITRA126C

NFI Canada Blue Day Cab Kit
Updated 4-1-2021

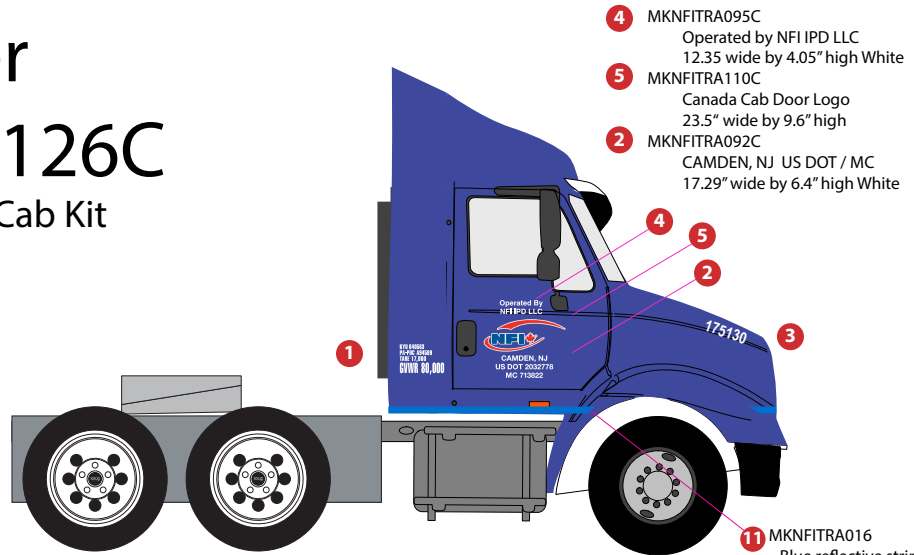

- 4 MKNFITRA095C
Operated by NFI IPD LLC
12.35 wide by 4.05" high White
- 5 MKNFITRA110C
Canada Cab Door Logo
23.5" wide by 9.6" high
- 2 MKNFITRA092C
CAMDEN, NJ US DOT / MC
17.29" wide by 6.4" high White

- 4 MKNFITRA095C
Operated by NFI IPD LLC
12.35 wide by 4.05" high White
- 5 MKNFITRA110C
Canada Cab Door Logo
23.5" wide by 9.6" high
- 2 MKNFITRA092C
CAMDEN, NJ US DOT / MC
17.29" wide by 6.4" high White

- 8 MKNFITRA174 -
Driver Reminder
3" wide by 3" high
Place on the back of
the visor inside cab

Attention: All Driver
Reminders are equipped with an
automated braking and
Lane-Departure System.

Please contact your Driver Manager
as soon as possible to review the
System Driver Training video on
MyLearning and/or My401!

www.nfi.com
www.nfi.net

- 1 Fuel Permit as profile
with no dot#
Shown at 50% of original
12.75" w by 8.78" h
Background color of blue does
not print, is there to show the white
profile cut letters.

- 11 MKNFITRA016
Blue reflective stripe

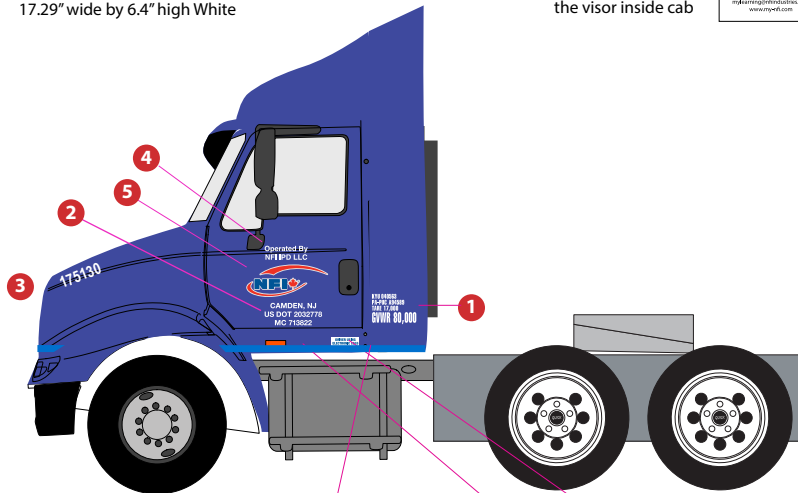

**KYU 040563
PA-PUC A94589
TARE 17,000
GVWR 80,000**

- 6 MKNFITRA114
NEW Air Shield logo
47" wide by 19.2" high

- 10 MKNFITRA016
Blue reflective stripe

- 9 MKNFITRA180 - Electronic Logs
8" wide by 2.5" high

Tire Check Reminder
NFI Standard
Steer Tires = 110 psi
Drive Tires = 100 psi
Trailer Tires = 100 psi
Check Air Pressure Daily
Calibrate Gauge Monthly

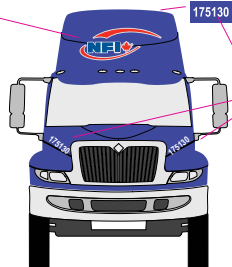

- 3 MKNFITRA094
5" 6 DIGIT UNIT #'S WHITE
Note: place on back of cab below
window

- 7 MKNFITRA164 - Tire Check Reminder
2.75" wide by 1.75" high
Placement instruction sheet attached

20% scale



PART NUMBER	QTY	DESCRIPTION
1	2	MKNFITRA089C CANADA FUEL PERMIT
2	2	MKNFITRA092C LOCATION/DOT #/ MC
3	3	MKNFITRA094 5" WHITE 6 DIGIT UNIT #'S
4	2	MKNFITRA095C OPERATED BY + NFI IPD LLC
5	2	MKNFITRA110C CANADA CAB DOOR LOGO
6	1	MKNFITRA114C CANADA AIR SHIELD LOGO
7	1	MKNFITRA164 TIRE CHECK REMINDER
8	1	MKNFITRA174 DRIVER REMINDER (FOR VISOR)
9	1	MKNFITRA180 ELECTRONIC LOG 8" X 2.5"
10	1	MKNFITRA016 BLUE REFLECTIVE 2" X 25' ROLL

Kit Number MKNFITRA126C

NFI Canada Blue

Day Cab Parts

Updated 4-1-2021

- 1** MKNFITRA089C - NFI Canada Fuel Permit
12.75" wide by 8.69" high
White diecut (blue does not print)



- 2** MKNFITRA092C - Canada Location, DOT, MC
17.29" wide by 6.36" high
White diecut (blue does not print)



- 3** MKNFITRL094 - UNIT NUMBER
5" white 6 digit Unit #'s
White diecut material



- 4** MKNFITRL095C- Operated by NFI IPD LLC
12.35" wide by 4.05" high
White diecut



- 5** MKNFITRA110C - Canada Cab Door Decal
23.5" wide by 9.33" high
Red and Blue on reflective diecut



- 6** MKNFITRA114C - NFI Canada Airshield logo
47" wide by 18.66" high
Red and Blue on reflective diecut



- 7** MKNFITRA164 - Tire Check Reminder
2.75" wide by 1.75" high
Green on white square cut
Placement instruction sheet attached



- 8** MKNFITRA174 - Driver Reminder
3" wide by 3" high
Place on back of visor inside cab
Black on white square cut



- 9** MKNFITRA177 - Long Stroke Brake
3" wide by 3" high
Black on white square cut

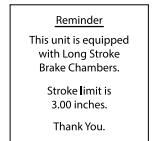

- 10** MKNFITRA180 - Long Stroke Brake
8" wide by 2.5" high
Blue on white square cut



- 11** MKNFITRA016 - Blue Reflective Stripe
2" high by 25' roll



MKNFITRA173C Canada Owner Operator Cab Kit

Updated 2-7-2020

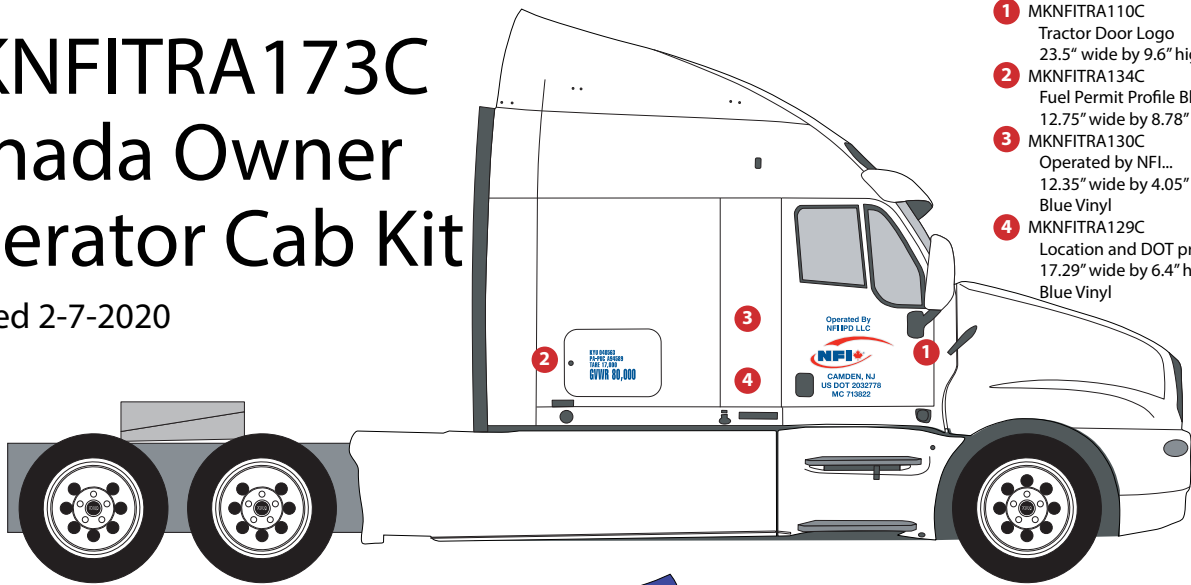

- 1 MKNFITRA110C
Tractor Door Logo
23.5" wide by 9.6" high
- 2 MKNFITRA134C
Fuel Permit Profile Blue Vinyl
12.75" wide by 8.78" high
- 3 MKNFITRA130C
Operated by NFI...
12.35" wide by 4.05" high
Blue Vinyl
- 4 MKNFITRA129C
Location and DOT profile
17.29" wide by 6.4" high
Blue Vinyl

Note: If the cab is light, use the blue vinyl markings as indicated.

- 8 MKNFITRA180 for use on blue trucks

**DRIVER USING
ELECTRONIC LOGS**

- 9 MKNFITRA181 for use on white trucks

**DRIVER USING
ELECTRONIC LOGS**

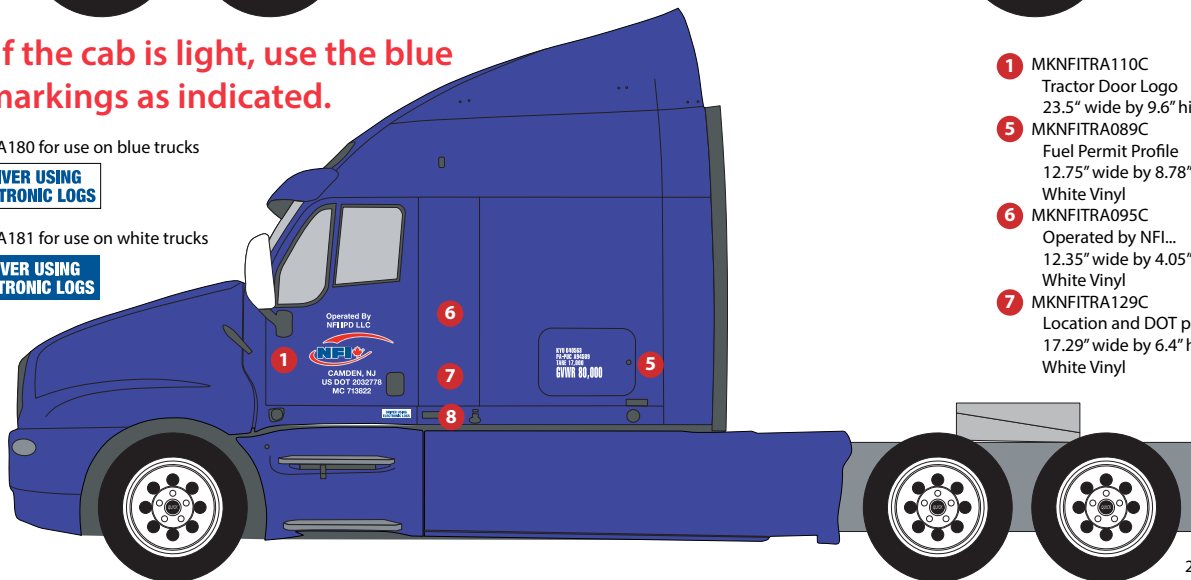

- 1 MKNFITRA110C
Tractor Door Logo
23.5" wide by 9.6" high
- 5 MKNFITRA089C
Fuel Permit Profile
12.75" wide by 8.78" high
White Vinyl
- 6 MKNFITRA095C
Operated by NFI...
12.35" wide by 4.05" high
White Vinyl
- 7 MKNFITRA129C
Location and DOT profile
17.29" wide by 6.4" high
White Vinyl

20% scale

Note: If the cab is dark use the white vinyl markings.

PART NUMBER QTY DESCRIPTION

<u>PART NUMBER</u>	<u>QTY</u>	<u>DESCRIPTION</u>
1 MKNFITRA110C	2	Tractor DOOR LOGO
2 MKNFITRA134C	2	Fuel Permit Profile Blue Vinyl
3 MKNFITRA129C	2	Location, US DOT Blue Vinyl
4 MKNFITRA130C	2	Operated by NFI... Blue Vinyl
5 MKNFITRA089C	2	Fuel Permit Profile White Vinyl
6 MKNFITRA095C	2	Operated by NFI... White Vinyl
7 MKNFITRA092C	2	Location, US DOT White Vinyl
8 MKNFITRA180	1	Electronic Log for blue cab
9 MKNFITRA181	1	Electronic log for white cab



Kit Number MKNFITRA173C National Freight Canada Owner Operator Cab Kit Parts Updated 2-7-2020

- 1** MKNFITRA110C - Canada Tractor Door Logo
23.5" w by 9.6" h
Blue and red on reflective diecut



- 2** MKNFITRA134C - Fuel Permit Profile Blue
12.75" w by 8.78" h
Blue diecut vinyl

**KYU 040563
PA-PUC A94589
TARE 17,000
GVWR 80,000**

- 3** MKNFITRA130C - Operated By NFI IPD LLC
12.35" w by 4.05" h Blue diecut vinyl

**Operated By
NFI IPD LLC**

- 4** MKNFITRA129C- Location and DOT profile
17.29" w by 6.4" h
Blue diecut vinyl

**CAMDEN, NJ
US DOT 2032778
MC 713822**

- 5** MKNFITRA089C - Fuel Permit Profile white
12.75" w by 8.78" h
White diecut vinyl

**KYU 040563
PA-PUC A94589
TARE 17,000
GVWR 80,000**

- 6** MKNFITRA095C- Operated By NFI IPD LLC
12.35" w by 4.05" h White diecut vinyl

**Operated By
NFI IPD LLC**

- 7** MKNFITRA092C - Location and DOT profile
17.29" w by 6.4" h
White diecut vinyl

**CAMDEN, NJ
US DOT 2032778
MC 713822**

- 8** MKNFITRA180 - Electronic Log
8" w by 2.5" h for use on blue cabs
Square Cut

**DRIVER USING
ELECTRONIC LOGS**

- 9** MKNFITRA181 - Electronic Log
8" w by 2.5" h for use on white cabs
Square Cut

**DRIVER USING
ELECTRONIC LOGS**

MKNFITRA164 - Tire Check Reminder Decal

2.75" wide by 1.75" high

Updated 9-17-2018

The tire check reminder decal will be mounted on the seat support bracket.

Shown below are photos of the proper mounting of the decal.



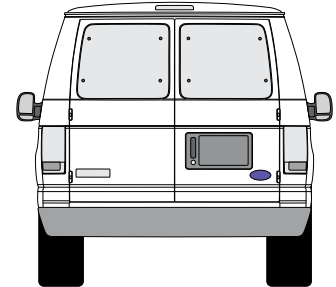
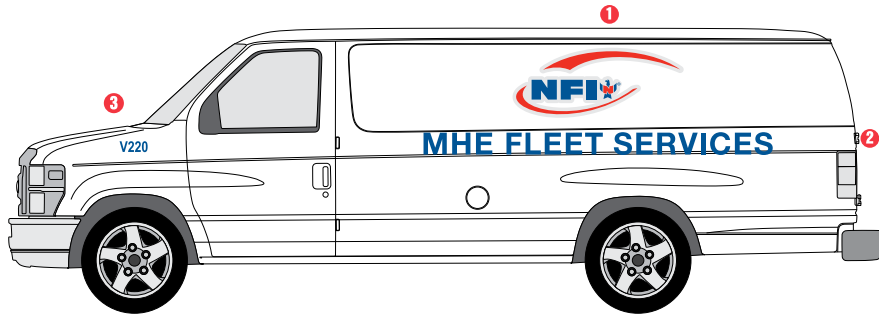
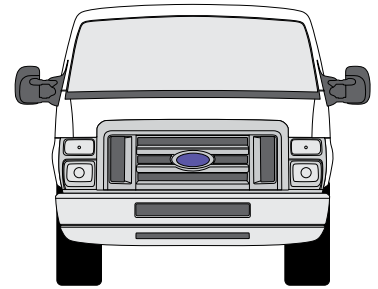
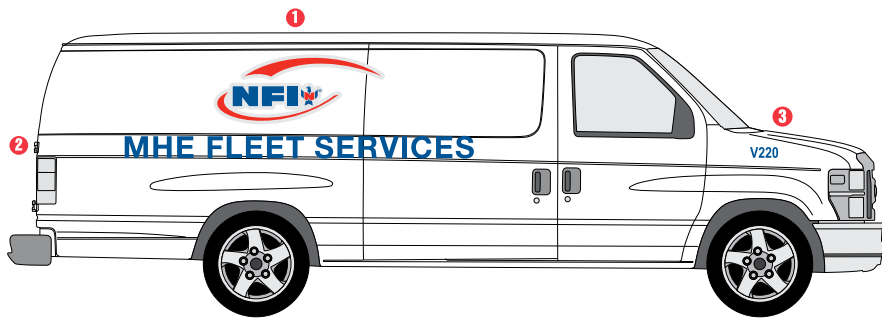

- ❶ 2 each MKNFITRL114 - 47" wide by 19.2" high, Red and Blue, diecut reflective material
- ❷ 2 each MKNFIPL0T MHE - 6" High "M" - 96" wide by 6.265" high, sapphire blue plotter cut vinyl
- ❸ 2 each MKNFIPL0T 3" Unit Number - 4 digit sapphire blue plotter cut vinyl

NFI MHE FLEET SERVICES Large Logo E-350 Extended Van layout
 2-7-2020 • pz

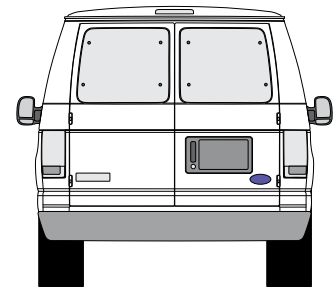
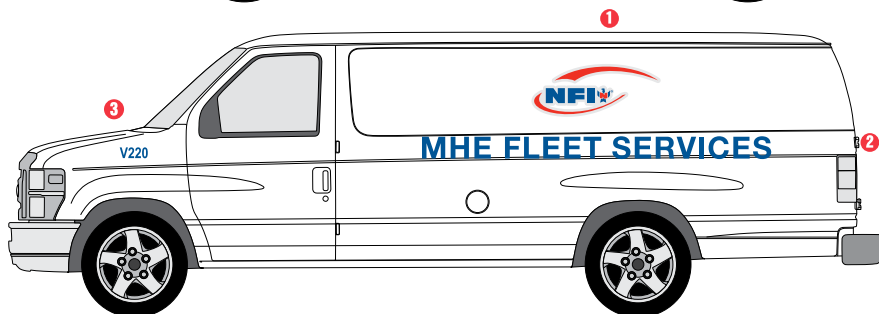
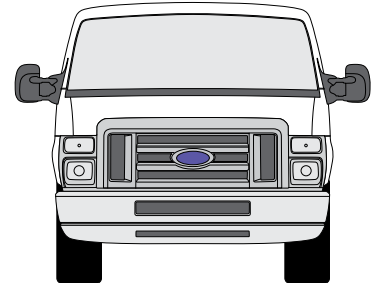

- ❶ 2 each MKNFITRL110 - 35.5" wide by 115" high, Red and Blue, diecut reflective material
- ❷ 2 each MKNFIPL0T MHE - 6" High "M" - 96" wide by 6.265" high, sapphire blue plotter cut vinyl
- ❸ 2 each MKNFIPL0T 3" Unit Number - 4 digit sapphire blue plotter cut vinyl

NFI MHE FLEET SERVICES Small Logo E-350 Extended Van layout 2
 2-7-2020 • pz



Kit Number MKNFITRL169

NFI Transportation Box/Straight Truck • Updated 2-7-2020

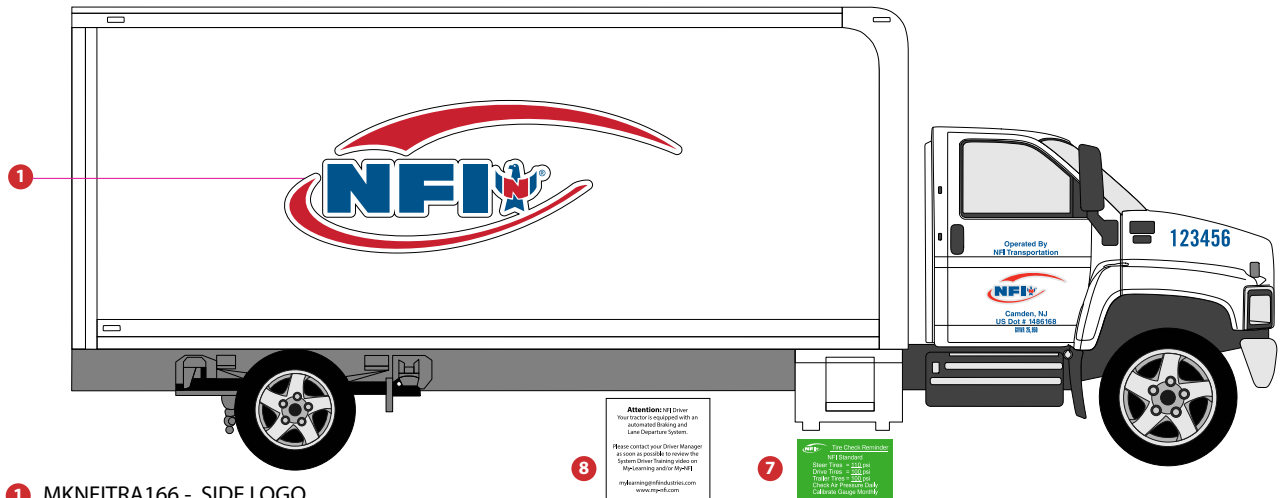

- 1 MKNFITRA166 - SIDE LOGO
115" w x 44.15" h
- 5 MKNFITRA135 - Operated by NFI...
18.56" w x 4.46" h



- 6 MKNFITRA090- Tractor Door Logo
23.5" w by 9.6" h
- 7 MKNFITRA164 - Tire Check Reminder
2.75" w by 1.75" h
Placement instruction sheet attached
- 8 MKNFITRA174 - Driver Reminder
3" w by 3" h
Place on the back of the visor inside cab
- 9 MKNFITRA168 - Location and DOT Profile
17.32" w by 3.92" h
- 10 MKNFILOT - GRVW
6.5" w by 1.8" h
- 11 MKNFITRA181 - ELECTRONIC LOG
8" w by 2.5" h
- 12 MKNFITRA131 - Unit Numbers
(1 on each tractor door and rear door)
5" tall- 6 digit numbers

**DRIVER USING
ELECTRONIC LOGS**

- 2 MKNFITRL161 -
95% safe driver combo
24" w by 24" h
- 3 MKNFITRL110 -
Rear and Front Logo
35.5" w by 13.63" h
- 4 MKNFITRL052 -
WIDE TURN
17" w by 13" h

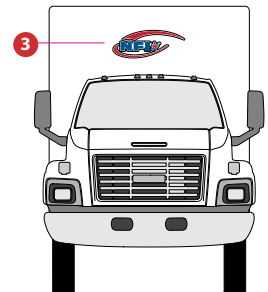
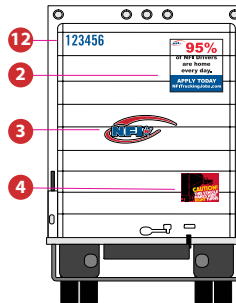

PART NUMBER	QTY	DESCRIPTION
1	2	STRAIGHT TRUCK SIDE LOGO
2	1	95% SAFE DRIVER COMBO
3	2	REAR AND FRONT LOGO
4	1	WIDE TURN
5	2	OPERATED BY NFI TRANS...
6	2	TRACTOR DOOR LOGO
7	1	TIRE CHECK REMINDER
8	1	DRIVER REMINDER (FOR VISOR)
9	2	LOCATION AND DOT PROFILE
10	1	GRVW
11	1	ELECTRONIC LOG 8" X 2.5"
12	1	UNIT NUMBER SET 5"

